



## JORDAHL® Channels and Accessories

Making Light Work of the Heaviest Loads.

Technical Information



**JORDAHL®**  
anchored in quality

# Quality Since 1907

## JORDAHL – The Company

JORDAHL connects: steel, heavy loads, and a whole lot more. Many customers around the world have already decided on high-quality products for fastening, reinforcement, shear connections, framing, and facade connection systems. Customers who choose JORDAHL want more – higher quality, broader choice, better consulting services, wider experience. They get all of this from JORDAHL. Since our company was founded in Germany in 1907, we have been at the forefront of connection and shear reinforcement system development.

JORDAHL products, such as anchor channels, have become milestones in the evolution of structural engineering and have brought lasting changes to construction, shaping the way buildings are designed and making them safer, around the world.

JORDAHL's registered office and administrative headquarters in Berlin



## JORDAHL Advice

We not only set high standards with our products, but with technical consultation as well. Our competent and experienced JORDAHL experts are always aware of the latest developments and offer modern, flexible, and customised solutions to cater to all your needs. The more than 700 emails and calls to JORDAHL experts every day at our technical department in Berlin show just how much our customers appreciate the advice. Our more than 50 engineers available around the world can develop the right solution for your very specific application. Simply send an email to [experten@jordahl.de](mailto:experten@jordahl.de) or give us a call at +49 30 682 83-433 to contact the JORDAHL experts.

### Benefit from the expertise of JORDAHL experts, in areas including:

- Advice on our products
- Information about new products
- Customised solutions for your application
- Software issues
- Development of installation methods for your site planning
- Optimised solutions for economical use of our products
- Training and further development for architects, engineers, and design engineers
- Direct on-site service

# Table of Contents

<b>JORDAHL® Channels and T-Bolts</b>	<b>4 – 11</b>	<b>Toothed T-Bolts and Double-Notch Toothed T-Bolts</b>	<b>54</b>
<b>Applications and Uses</b>	4	Range of Toothed T-Bolts	54
<b>Approvals and Certificates</b>	8	Range of Double-Notch Toothed T-Bolts	54
<b>Advantages and Features</b>	9	Design Resistances and Bending Moments	55
<b>Material and Identification</b>	10	<b>Pre-Loaded Bolt Connections</b>	56
<b>Corrosion Prevention</b>	11	<b>Loading Hook-Head T-Bolts in Longitudinal Direction of Channel</b>	58
<b>JORDAHL® Anchor Channels</b>	<b>12 – 39</b>	<b>JORDAHL Accessories</b>	<b>59 – 68</b>
<b>JORDAHL® Anchor Channels JTA-CE</b>	12	<b>T-Bolt Accessories</b>	60
Profile Overview	14	Washers	60
JORDAHL® EXPERT Software	16	JORDAHL® Square Shim JVL	60
<b>JORDAHL® Toothed Anchor Channels JXA, JZA, and JXA-PC</b>	18	JORDAHL® Double-Toothed Shims	61
Profile Overview	20	Spring Washers (DIN 127)	61
Design Resistances	22	Self-Locking Nuts with Serrated Bearing	61
Minimum Distances and Minimum Dimensions	22	Hexagon Nuts according to ISO 4032	61
Anchor Channels JXA-PC	23	<b>JORDAHL® Sliding Nuts</b>	62
<b>JTA-CE, JXA, and JZA Product Range</b>	24	<b>Threaded Rods DIN 976-1</b>	63
<b>Fire Exposure</b>	25	<b>Flange Clamping Plates, Clamping Claw</b>	63
<b>Dynamic Load</b>	26	<b>Ring Nuts according to DIN 582</b>	64
<b>Site Use</b>	28	<b>JORDAHL® Toothed Straps JVB</b>	64
Installation	29	<b>JORDAHL® Turnbuckle Connections JSV</b>	66
Tightening Torque	29	<b>JORDAHL® Pressure Bolts JDS</b>	67
<b>Customised Solutions</b>	30	<b>Coupling Sleeves</b>	68
Anchor Channel Pairs	31	<b>Eyelet Sockets/Sleeve Anchors</b>	68
Anchor Channel Corner Pieces	31		
Curved Anchor Channels	31	<b>JORDAHL® Channels for Self-Drilling Screws JTB</b>	<b>69 – 73</b>
Handrail Connection Channels JGB	33	<b>Technical Details</b>	71
Facade Connection Channels JTA-RF and JTA-RT	35	<b>Installation and Assembly</b>	72
Anchor Channels JSA	37		
Anchor Channels JRA	38	<b>JORDAHL® Products for Brick Restraint</b>	<b>74 – 75</b>
 		<b>Brick Tie Anchors JMA and Nail Anchors JNA</b>	74
<b>JORDAHL® Mounting Channels</b>	<b>40 – 47</b>	<b>Brick Tie Channels</b>	75
<b>Hot-Rolled Mounting Channels</b>	42		
Mounting Channels JM W	42	<b>JORDAHL® Scaffold Shoes JG</b>	76
Toothed Mounting Channels JXM W	42	<b>JORDAHL® Edge Protection Angles JKW</b>	77
Welded or Bolted Attachment of Mounting Channels	43	<b>JORDAHL® Channel Brackets JKO</b>	78
<b>Cold-Formed Mounting Channels</b>	44	<b>Advice and Service</b>	79
Mounting Channels JM K	44		
Toothed Mounting Channels JZM K	45		
Slotted-Back Mounting Channels JML K	45		
<b>Technical Details</b>	46		
<b>JORDAHL® T-Bolts</b>	<b>48 – 58</b>		
<b>Determining the T-Bolt Length</b>	49		
<b>Position Identification</b>	49		
<b>Hook-Head and Hammer-Head T-Bolts</b>	50		
Range of Hook-Head T-Bolts	50		
Range of Hammer-Head T-Bolts	51		
Design Resistances and Bending Moments	52		

# JORDAHL® Channels and T-Bolts

## Applications and Uses

JORDAHL® anchor channels together with the matching JORDAHL® T-bolts create an excellent connection system. They are cast in and reliably transfer high loads into reinforced and unreinforced concrete components. Highly versatile, JORDAHL® anchor channels and T-bolts with European Technical Approval (ETA) and other international approvals can be used in a wide variety of

applications. Thanks to their many benefits for installation and assembly, as well as their first-class reliability and quality, they are the favourite among design engineers and users around the world. They have been tried and tested in countless international projects, setting standards for fastening technology.

### Elevator Installation

JORDAHL® anchor channels and T-bolts offer a secure and adjustable system for safely anchoring elevator guide rails and doors. The dynamic loading conditions are safely resisted for millions of cycles. Here used at Torre PwC, formerly Torre Sacyr Vallehermoso, the third highest building in Spain at 236 m.



Torre PwC and Torre Cepsa in Madrid, Spain

### Curtain Wall

JORDAHL® anchor channels and T-bolts meet the demands of modern facade engineering. Many of the glass facades in the Canary Wharf business district of London utilise the reliability and design versatility of JORDAHL products.



Canary Wharf London, United Kingdom

## Tunnel Construction

JORDAHL® anchor channels, manufactured as pairs, provide for easy placement and offer simple connection-location adjustment for the long-term resistance of dynamic loading applied to catenaries, overhead lines, signaling systems, lights, and ventilation in tunnels – as here, in the City Tunnel in Leipzig.



## Stadium Construction

JORDAHL® anchor channels and T-bolts are used in stadium construction because they provide a simple, adjustable, and safe way to fasten both seats and crowd-control handrails to concrete without noise or dust – as in the ETO Park stadium in Győr, Hungary. The variable adjustment of the distances between seats is a major advantage.



## Precast Construction

Small edge distances, corrosion-free and therefore exceptionally long-lasting material, and ETA approval are just some of the reasons why JORDAHL® anchor channels are used at JadeWeserPort/ Wilhelmshaven and around the world to connect beams and walls.



## Applications and Uses

### Bridge Construction

ETA-approved JORDAHL® anchor channels provide reliable connections for communication and power cables plus water supply and drainage pipes. Here demonstrated at the Spandauer Damm Bridge in Berlin, as one of numerous international projects.



Spandauer Damm Bridge in Berlin, Germany

### Industrial Construction

JORDAHL® channels for self-drilling screws are the perfect solution for fastening profiled metal sheets to reinforced concrete structures in industrial structures without damaging the load-bearing concrete components. Illustrated here is a project for FIEGE Logistics in Greven.



FIEGE Logistics in Greven, Germany

### Power Station Construction

Toothed JORDAHL® anchor channels are approved for dynamic impact and fatigue loads, and are highly resistant to seismic loads and fire. They are therefore ideally suited to safety-critical applications – such as the Neurath Power Station in Grevenbroich.



Neurath Power Station in Grevenbroich, Germany

## Crane Rails

Hot-rolled JORDAHL® anchor channels are ideally suited to dynamic loads and withstand fatigue over millions of cycles. They therefore meet all requirements for reliable fastening of crane rails – and are used for this purpose at our own production hall and warehouse in Trebbin.



## Structural Engineering

JORDAHL® anchor channels JTA and toothed channels JXA make it easy to balance construction tolerances and are highly resistant to fatigue and vibrations. At the new ship lift in Niederfinow, they guarantee that machinery and plant systems are securely fastened in concrete.



## Handrail Connections

JORDAHL® handrail connection channels JGB, with their extra-long anchors, deliver versatile solutions for handrail connections to concrete slabs of 10 cm and greater. As in the MyZeil shopping centre – considered architecturally as one of the most modern shopping centres in Europe with its curved and partially inverted glass structure.



# JORDAHL® Channels and T-Bolts

## Approvals and Certificates



### European Technical Approval (ETA)

The German Institute for Construction Engineering (DIBt) has issued a European Technical Approval for JORDAHL® anchor channels JTA-CE and T-bolts. The ETA approval assesses these products both technically and in terms of quality. The approval is based on a general European design concept that is valid without restrictions in more than 30 countries and ensures maximum planning reliability even in international projects. JORDAHL has also received similar approvals for its channel and T-bolt products in North America and Asia.



### German Technical Approval (Allgemeine bauaufsichtliche Zulassung – abZ)

Some types of building products cannot be qualified with a European Technical Assessment (ETA) because a European Assessment Document (EAD) has not yet been created by the review body. However, in these cases (such as the JORDAHL® channels for self-drilling screws JTB and the JORDAHL® double shear connectors JDSD) a German Technical Approval (abZ) is available. These products are labelled with the Ü symbol to provide our customers with the confidence that these products are of the same standard and are safe to use according to a recognised design standard.



### TÜV Rheinland Certified – ISO 9001

The TÜV Quality Mark confirms that JORDAHL production undergoes strict quality control in accordance with the requirements of German and European certification procedures (ISO 9001:2008).



### Approvals for North America and China

JORDAHL® anchor channels JTA are approved by CABR for China and IAPMO and ICC for the North American market.



#### JORDAHL Information

Interested in our approvals? They are available to download via QR code (simply scan, select the document you require, and download) or as a standard download from [www.jordahl.de](http://www.jordahl.de) → Downloads → Approvals.





## Advantages and Features

### Planning

- Economical connection systems thanks to a range of anchor channels optimised and graded by load class
- Maximum reliability thanks to flexible design concept based on Eurocode (EC2)
- Optimal corrosion protection in every corrosion category by using hot-dip galvanised steel or stainless steel
- Rapid creation of verifiable structural calculations – thanks to transparent, user-friendly, and powerful JORDAHL® EXPERT design software
- Planned reinforcement can be included in the design
- Maximum versatility in connection locations due to the infinitely variable T-bolt spacing and positioning offered by cast-in anchor channels
- Secure anchoring in concrete, even at low edge distances and in filigree concrete components
- Suitable for prestressed elements
- Can be used in cracked concrete zones, regardless of reinforcement



### Safety

- Suitable for cracked and uncracked concrete, without restrictions
- No damage to concrete or reinforcement
- Resistant to fatigue and loads caused by seismic vibrations or explosions
- Optimal undercut mechanical anchoring in concrete
- Transparent safety concept (γ-procedure)
- Approved for installation in elements with fire-protection requirements
- Maintenance-free for years thanks to corrosion-resistant stainless steel variants



### Installation

- Rapid on-site fastening of attached components to keep construction time to a minimum
- Only simple hand tools required
- No drilling, no welding, no power supply needed
- No noise, no dust, no fire risk
- Simple compensation of construction tolerances



hot-rolled profile



cold-formed profile



toothed profile



work safety



reduces construction time



economical



simple assembly



fire prevention



sustainable construction



#### JORDAHL Information

Do you need JORDAHL installation instructions? They are available to download via QR code (simply scan, select the document you require, and download) or as a standard download from [www.jordahl.de](http://www.jordahl.de) → Downloads → Installation instructions.



# JORDAHL® Channels and T-Bolts

## Material and Identification

The quality of the raw material is vital for JORDAHL to offer maximum reliability and safety in its products.

JORDAHL therefore only purchases material from first-class suppliers. Quality has top priority at JORDAHL.

Material	Steel		Stainless Steel	
<b>Profiles</b>	S235JR = 1.0038 S275JR = 1.0044	DIN EN 10025	1.4301/1.4541-A2 <sup>1)</sup> 1.4401/1.4404/1.4571-A4 <sup>2)</sup> 1.4529/1.4547 <sup>3)</sup>	DIN EN 10088
<b>Anchor</b>	S235JR = 1.0038	DIN EN 10025 DIN EN 10263	1.4401/1.4404/1.4571-A4 <sup>2)</sup> 1.4529/1.4547 <sup>3)</sup>	DIN EN 10088
<b>T-Bolts</b>	Strength grade 4.6/8.8	DIN EN ISO 898-1	A4-50; A4-70 <sup>2)</sup> F4-70 <sup>3)</sup>	DIN EN ISO 3506-1
<b>Hexagon Nuts ISO 4032</b>	Strength grade 8	DIN EN 20898-2	A4-50; A4-70 <sup>2)</sup> 1.4529 <sup>3)</sup>	DIN EN ISO 3506-2
<b>Washers</b>	Steel	DIN EN ISO 7089 (DIN 125) DIN EN ISO 7093-1 (DIN 9021)	1.4401/1.4404/1.4571-A4 <sup>2)</sup>	DIN EN 10088

<sup>1)</sup> Corrosion resistance class II according to Z-30.3-6 (not included in the ETA).

<sup>2)</sup> Corrosion category C4 (ISO 12944-2).

<sup>3)</sup> Corrosion category C5 (ISO 12944-2).

### Identification of JORDAHL® anchor channels

JORDAHL® anchor channels are permanently marked on the profile with profile type and material specification.

JORDAHL® anchor channels JTA-CE that are designed according to the European Technical Approval (ETA) are marked "-CE".

JORDAHL® anchor channels with round anchors are also stamped with the profile designation on the rivet head in the channel cavity.

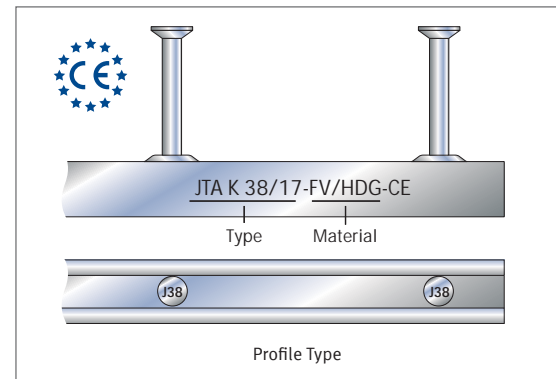

### Identification of JORDAHL® T-bolts

JORDAHL® T-bolts are embossed with type and strength grade on the bolt head.

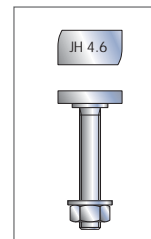

#### JORDAHL Information

Want to find out more? The declarations of performance and the certificates of conformity are available to download via QR code (simply scan, select the document you require, and download) or as a standard download from [www.jordahl.de](http://www.jordahl.de) → Downloads → Certification.



## Corrosion Prevention

Corrosion Categories: ISO 12944-2	Profile	Anchor	T-Bolt, Nut, Washer	Intended Use
C1 very low	Mill finish	Mill finish	Mill finish without corrosion protection	Only possible when all the connection elements, depending on the ambient conditions, are protected by a minimum concrete cover in accordance with Eurocode EC2.
C2 low	Hot-dip galvanised (HDG), plating $\geq 50 \mu\text{m}$	Hot-dip galvanised (HDG), plating $\geq 50 \mu\text{m}$	Zinc electroplated (ZP), plating $\geq 5 \mu\text{m}$	Concrete components in interior rooms – for example, domestic properties, offices, schools, hospitals, retail premises – with the exception of wet rooms.
C3 medium	Hot-dip galvanised (HDG), plating $\geq 50 \mu\text{m}$	Hot-dip galvanised (HDG), plating $\geq 50 \mu\text{m}$	Hot-dip galvanised (HDG), plating $\geq 40 \mu\text{m}$	Concrete components in interior rooms with normal atmospheric humidity (including kitchens, bathrooms, and washrooms in domestic properties) – with the exception of permanent moisture penetration.
C4 high	Stainless steel 1.4401 1.4404 <b>6</b> A4 1.4571 1.4362 L4	Round anchor: Stainless steel 1.4401 1.4404 <b>6</b> A4 <sup>1)</sup> 1.4571 1.4362 L4 <sup>1)</sup> Weld-on anchor: Mill finish <sup>2)</sup>	Stainless steel 1.4401 1.4404 <b>6</b> A4-50, 1.4571 A4-70 1.4362 L4-70	Applications with medium corrosion resistance – for example, in wet rooms, areas exposed to weather, industrial atmospheres, rooms with proximity to the sea, and inaccessible areas.
C5 severe	Stainless steel 1.4462 <sup>3)</sup> F4 <sup>4)</sup> 1.4529 <b>6</b> HC 1.4547	Round anchor: Stainless steel 1.4462 <sup>3)</sup> F4 <sup>4)</sup> 1.4529 HC Weld-on anchor: Mill finish <sup>2)</sup>	Stainless steel 1.4462 <sup>3)</sup> F4-70 <sup>4)</sup> 1.4529 HC-50 1.4547 HC-70	Applications with severe corrosion resistance and high exposure to corrosion by chlorides and sulphur dioxide (including the concentration of pollutants – for example in the case of components used in saltwater and road tunnels).

<sup>1)</sup> JORDAHL® stainless steel anchor channels with round anchors:  
Anchor channel types JTA K 28/15 to JTA W 53/34, JXA W 29/20 to JXA W 53/34 are manufactured from stainless steel round anchors. These anchor channels are not subject to any restrictions with respect to the concrete cover.

Anchor channel types JTA W 72/48, JTA K 72/48, JTA W 53/34, JTA K 53/34, JXA W 64/44, and JXA W 53/34 can be manufactured from stainless steel round anchors or welded-on mill finish steel I-anchors. The load-bearing properties of the round anchors or welded-on I-anchors are equivalent.

<sup>2)</sup> JORDAHL® stainless steel anchor channels with mill finish welded anchors:  
The following concrete cover *c* must be used for corrosion protection of the welded anchors:

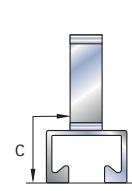
JTA W 53/34 JTA K 53/34 JXA W 53/34 [mm]	JXA W 64/44 [mm]	JTA W 72/48 JTA K 72/48 [mm]	
40	50	60	

<sup>3)</sup> Stainless steel 1.4462 is not approved for indoor swimming pool atmospheres in accordance with Z-30.3-6.

<sup>4)</sup> F4 is equivalent to FA.

# JORDAHL® Anchor Channels

## Anchor Channels JTA-CE



European Technical  
Approval ETA-09/0338



JORDAHL® anchor channels with matching T-bolts create an excellent connection system for transferring loads to reinforced concrete components. Initial installation is fast and connections are easy to position accurately. Connections can later be replaced or repositioned at any time to match new fastening requirements. They are a key part of the wide-ranging JORDAHL portfolio of products and can be used for a wide variety of different applications.

### Extensive Benefits

- Fast, efficient, and adjustable fastening of large loads
- Maintenance-free for years, with a choice of high-quality galvanised, or stainless steel products
- Installation without damaging concrete or reinforcement
- Approved throughout Europe **ETA-09/0338**



### Maximum Design Reliability

- Secure fastening thanks to design concept that is Eurocode-compatible
- JORDAHL® EXPERT software for reliable and efficient design of JORDAHL® anchor channels
- Free download at [www.jordahl.de](http://www.jordahl.de)

### Powerful Features

- Suitable for cracked and uncracked concrete and prestressed elements, without restrictions
- Secure fastening in elements with fire-protection requirements up to R120
- Increased load-bearing capacity near to reinforcement, including in filigree elements



Overhead line in tunnel



Bridge pipe suspension



Crane rails/precast supports



Curtain walls

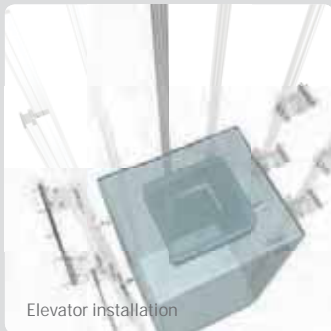

Elevator installation

## Fastening Solutions

- Overhead lines in tunnels and on railway lines
- Precast concrete elements
- Stadium seats
- Crane rails
- Cable support systems
- Elevator guide rails and doors
- Industrial machinery
- Curtain walls
- Pipework



Fastening stadium seats

## Anchor Channels JTA W – for Dynamic Loads

- Hot-rolled from a single block and therefore free of residual stress
- High fatigue strength under dynamic load
- Economical and optimised design for any number of load cycles
- Tested for explosion and shock loads



Anchor channels JTA W 53/34 with JORDAHL® T-bolt JB



## Anchor Channels JTA K – for Static Loads

- Cold-formed, round-edged
- Constant material thickness
- Suitable for constant static loads only
- Low weight combined with high static load performance
- Optimised geometry with strengthened channel lips for high tightening torques



Anchor channels JTA W 38/17 with JORDAHL® T-bolt JH



## Anchor Channels JTA-CE

Profile Overview<sup>1)</sup>

## Hot-Rolled Anchor Channels

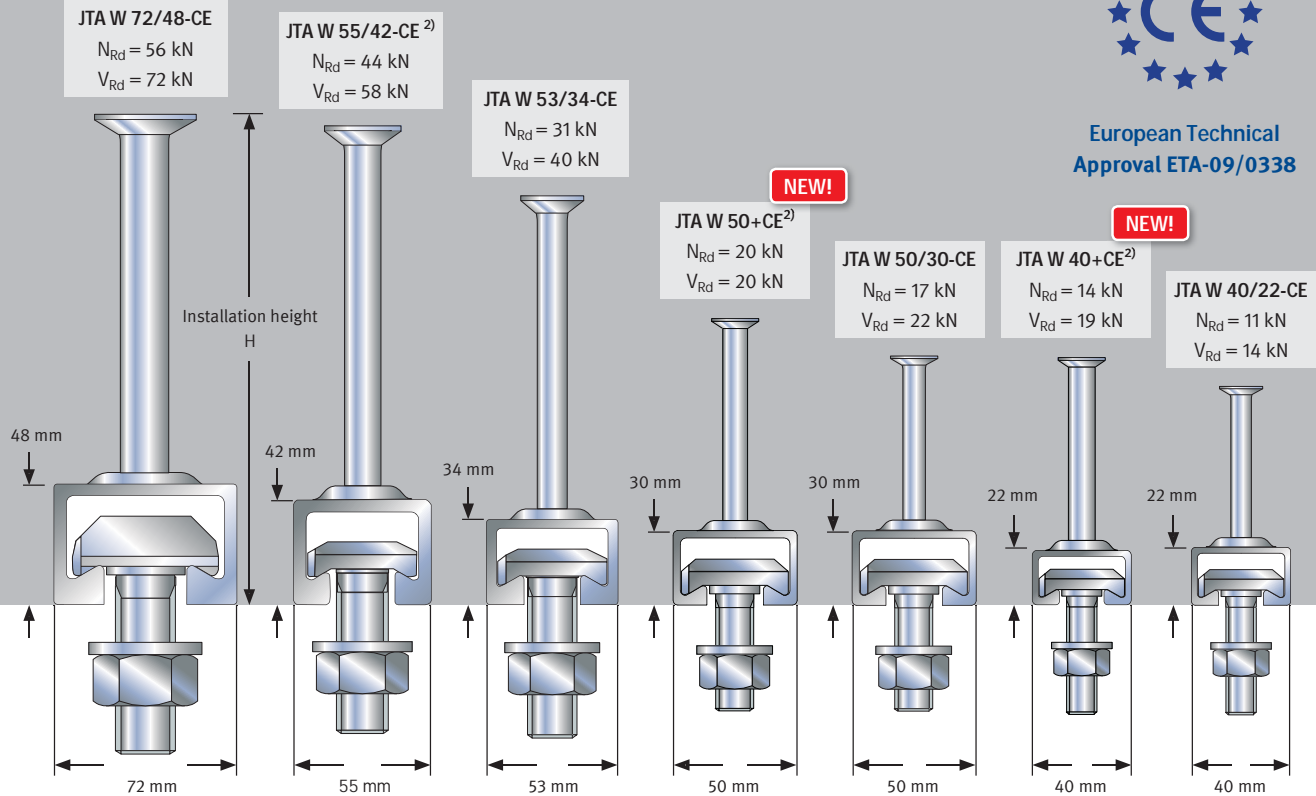
European Technical  
Approval ETA-09/0338Min. Edge Distance  $c_{min}$  [mm]<sup>4)</sup>

150	100	100	75	75	50	50
-----	-----	-----	----	----	----	----

## Installation Height H [mm]

195	190	165	115	100	100	90
-----	-----	-----	-----	-----	-----	----

## T-Bolts

JA	JB	JB	JB	JB	JC	JC
M 20	M 16	M 10	M 10	M 10	M 10	M 10
M 24	M 20	M 12	M 12	M 12	M 12	M 12
M 27	M 24 <sup>3)</sup>	M 16	M 16	M 16	M 16	M 16
M 30		M 20	M 20	M 20		

## Profile Material and Design

- Hot-dip galvanised steel (HDG)
- Stainless steel (A4)
- Standard filler: polyethylene (PE) or polystyrene (PS)<sup>5)</sup>

## T-Bolt Material

- Zinc electroplated (ZP) or hot-dip galvanised steel (HDG)
- Stainless steel (A4, F4)

<sup>1)</sup> Profile dimensions may exhibit tolerances.<sup>2)</sup> Only in hot-dip galvanised steel (HDG). <sup>3)</sup> JB M 24 is equivalent to JE M 24.<sup>4)</sup> If minimum distances are used, the load-bearing capacities may be reduced, because the load-bearing capacity of the concrete is the controlling variable.<sup>5)</sup> If using self-compacting concrete, we recommend PS filling only. $N_{Rd}$  = design value of the tension load $V_{Rd}$  = design value of the shear load

## Cold-Formed Anchor Channels



European Technical  
Approval ETA-09/0338

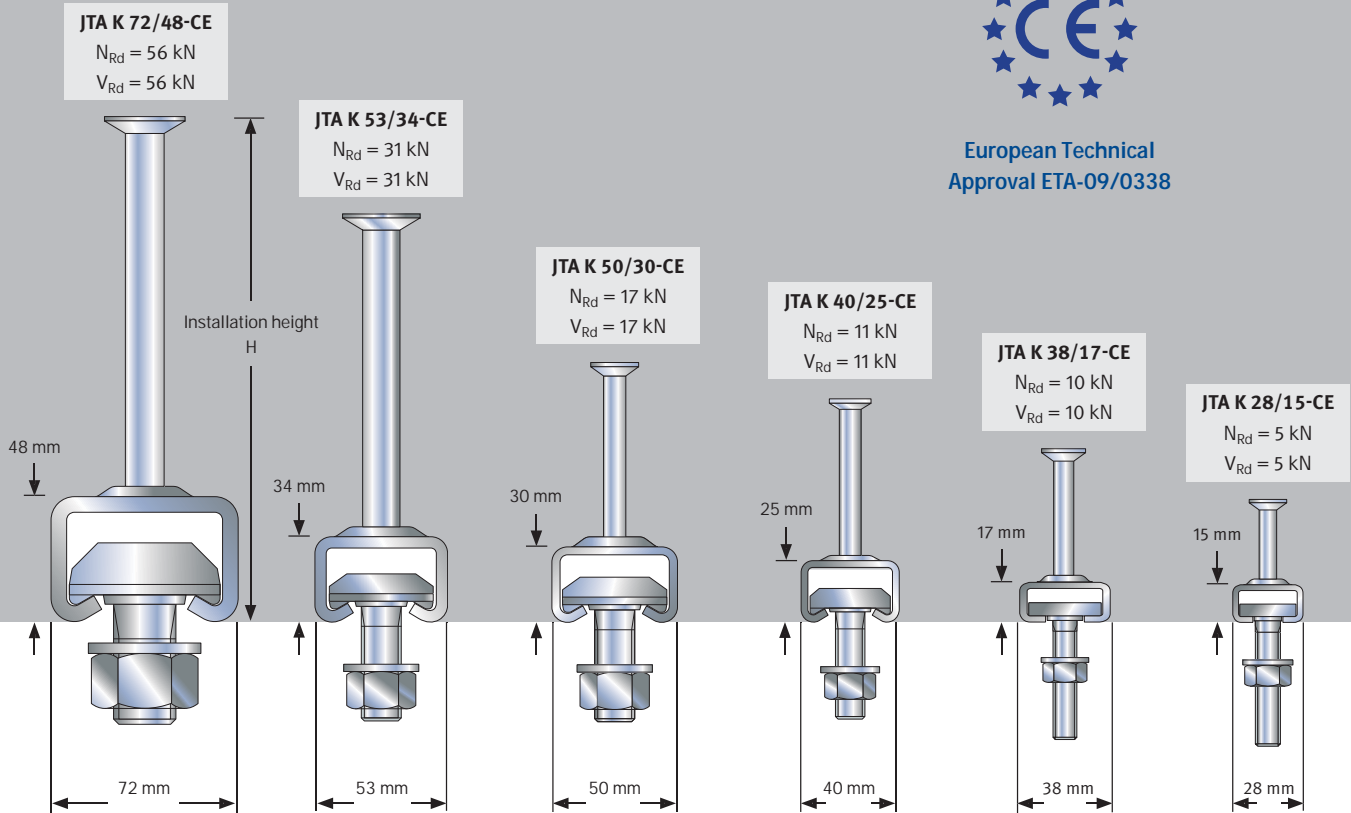

Min. Edge Distance  $c_{min}$  [mm]<sup>4)</sup>

150	100	75	50	50	40
-----	-----	----	----	----	----

Installation Height H [mm]

195	170	100	90	80	50
-----	-----	-----	----	----	----

### T-Bolts

JA	JB	JB	JC	JH	JD
M 20	M 10	M 10	M 10	M 10	M 6
M 24	M 12	M 12	M 12	M 12	M 8
M 27	M 16	M 16	M 16	M 16	M 10
M 30	M 20	M 20			M 12



### JORDAHL Downloads

Did you know that JORDAHL® anchor channels JTA-CE can be easily designed for a specific application with JORDAHL® EXPERT software? You can download the software free of charge at [www.jordahl.de](http://www.jordahl.de) → Downloads → Software.

## Anchor Channels JTA-CE

### JORDAHL® EXPERT Software

The software provides a user-friendly and secure way to verify anchoring of loads with JTA-CE anchor channels in concrete. The user can adjust inputs into the software so that the produced anchoring calculations are specific to the exact design conditions of the project. This enables

you to optimise the anchoring products selected for each condition both technically and economically. The program is based on the European Technical Approval ETA-09/0338. The design software for JORDAHL® anchor channels is compatible with Eurocode 2 (EC2).

#### Intuitive to use

- Simple and clear data entry
- Work directly on the interactive 3D graph
- No hidden functions
- Clear work structure
- Automatically determines the bolt loads
- Input checked immediately via real time changes
- Input commented in pop-up info boxes

#### Cost-effective calculation

- Allows project-specific load conditions to be entered
- Automatic edge-distance optimisation
- Overview of results with quantities of components
- Simple optimisation of the attached component geometry

#### Verifiable results

- Simple visual verification of results
- Graphical and text output
- Details of formulae and parameters that have been used



#### JORDAHL Downloads

You can download JORDAHL® EXPERT Software easily and free of charge at [www.jordahl.de](http://www.jordahl.de) → Downloads → Software.



### Extra Features

#### Edge reinforcement

When designing suitable anchoring products, JORDAHL® EXPERT software can take into account existing edge reinforcement and evaluate the effect of proposed additional reinforcement. The reinforcement condition can increase the load-bearing capacity of the concrete by up to 40%.



#### Dynamic load conditions

The software provides verification of anchoring fatigue resistance in dynamic conditions as well as checking suitability in static load conditions.

#### Fire exposure

For fire resistance of 90 and 120 minutes, the load-bearing capacities during a fire can be determined for fire exposure from one or multiple sides.





Approvals, design manuals, and catalogues  
 Specification texts and BOMs  
 Abbreviated and full printout  
 Calculation and results view

CAD details of the anchor channels  
 Updates  
 Language selection  
 3D/2D view

**Console**  
 The load can be entered directly via the console to calculate the bolt loads on the anchor channel automatically.

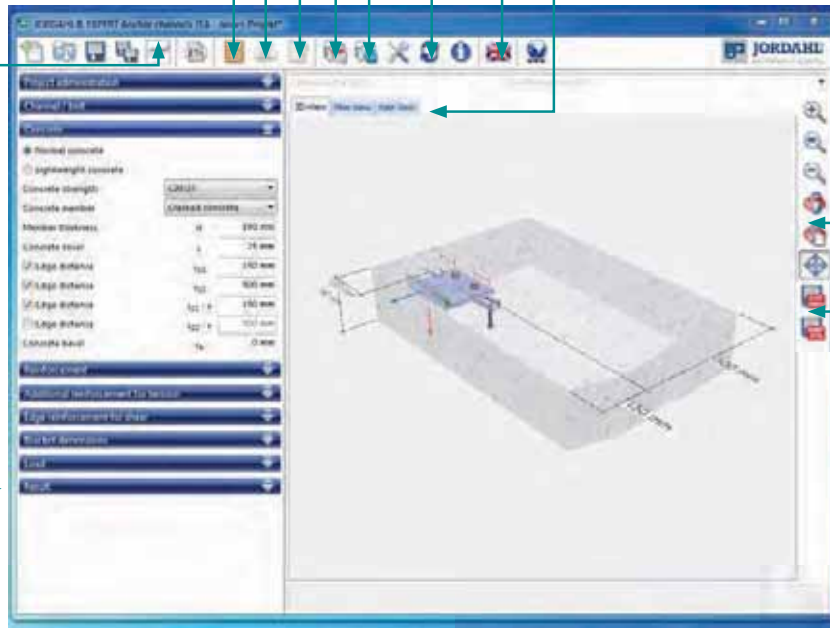

**Graphical display**  
 The current input parameters are displayed interactively and clearly in 3D. The view can be rotated, moved, and enlarged intuitively with the mouse.

The graphical representation can be exported as DXF/DWG to your CAD system

**Results**

The overview provides a summary of the results for all relevant channel variables at a glance. It is also possible to optimise the edge distances here.

The design results can be reviewed on the display screen as well as in the form of a printout.

Parameter	Value	Unit	Status
Concrete strength	25	N/mm <sup>2</sup>	OK
Concrete cover	25	mm	OK
Edge distance	75	mm	OK
Edge distance	75	mm	OK
Edge distance	125	mm	OK
Edge distance	125	mm	OK
Concrete class	C25/28		OK
Anchor length	150	mm	OK
Anchor diameter	16	mm	OK
Anchor type	Standard		OK
Anchor material	A500		OK
Anchor surface	Standard		OK
Anchor coating	Standard		OK
Anchor diameter	16	mm	OK
Anchor length	150	mm	OK
Anchor diameter	16	mm	OK
Anchor length	150	mm	OK

Detailed results: Product choices, maximum loads, and condition details are shown on the screen for checking and adjustment.



Printout of results: Clearly laid-out design printout with all relevant details for checking.



**JORDAHL Advice**

Do you need help in using JORDAHL® EXPERT Software? Just contact our JORDAHL experts by phone at +49 30 682 83-433 or by email at [experten@jordahl.de](mailto:experten@jordahl.de).



**JORDAHL service videos**

Find out about the benefits and design options with JORDAHL® EXPERT Software by watching one of our free software tutorials at [www.jordahl.de](http://www.jordahl.de) → Service → Software tutorials.



# JORDAHL® Anchor Channels

## Toothed Anchor Channels JXA, JZA, and JXA-PC



**German Technical Approval**  
Z-21.4-1690 (JXA)  
Z-21.4-741 (JZA)

JORDAHL® toothed anchor channels together with the matching JORDAHL® toothed T-bolts produce a reliable, positive connection without slippage. They are suitable for supporting loads in all directions and offer maximum dynamic load capacity for non-static load conditions. A comprehensive product range provides a choice of toothed JORDAHL® anchor channels that are suitable for a huge range of fastening requirements.

### Extensive Benefits

- Fast, efficient, and adjustable fastening of large loads
- Design with universal load-bearing capacity in all directions
- Installation without damaging concrete or reinforcement
- Integrates superbly into heavily reinforced concrete and filigree elements
- Easy positioning of connections for attached components makes it possible to compensate for construction tolerances
- Also approved as connections designed for fire risk



### Powerful Features

- Technical approval
- Suitable for cracked and uncracked concrete, without restrictions
- Suitable for supporting loads in all directions (longitudinal load, shear load, and central tension)

Curtain wall on the Metropolitan in Poland



Light and signalling systems

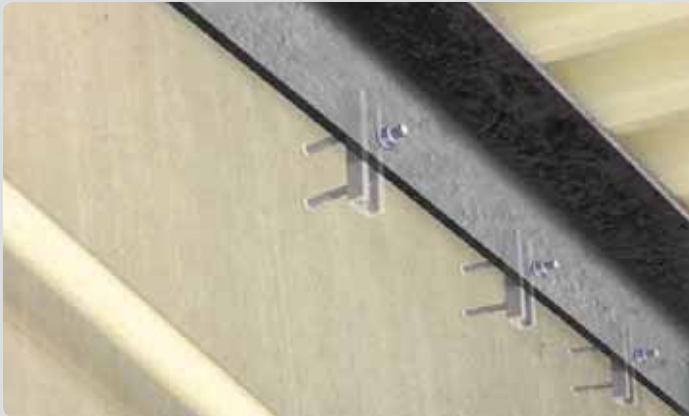

## Fastening Solutions

- Curtain walls
- Overhead lines in tunnels
- Power stations
- Elevator installation
- Light and signalling systems
- Cable support systems
- Pipework
- Precast concrete elements
- Steel to concrete connections requiring vertical adjustment

### Toothed Anchor Channels JXA W – for Dynamic Loads in All Directions

- Hot-rolled from a single block and therefore free of residual stresses
- Suitable for dynamic and seismic loads
- Optimised geometry with strengthened toothed channel lips for high-tightening torques
- Fatigue-resistant up to the limit of load-bearing capacity
- German Technical Approval **Z-21.4-1690**



Anchor channels JXA W 53/34 with JORDAHL® toothed T-bolt JXB



### Toothed Anchor Channels JZA K – for Static Loads in All Directions

- Cold-formed, round-edged
- Constant material thickness
- For regular static loads in all directions
- Low weight combined with medium-level static load performance
- German Technical Approval **Z-21.4-741**



Anchor channels JZA W 41/22 with JORDAHL® toothed T-bolt JZS



### Toothed Anchor Channels JXA-PC – for Seismic Loads and Safety-Related Applications

- Hot-rolled channels with large-headed ribbed anchors to compensate for heavily cracked concrete
- Proven for shock, fatigue, and dynamic loads
- Universal load-bearing capacity in all directions



Anchor channels JXA-PC W 53/34 with JORDAHL® toothed T-bolt JXB



## Toothed Anchor Channels JXA and JZA

Profile Overview<sup>1)</sup>

## Hot-Rolled Toothed Anchor Channels

abZ Z-21.4-1690

Cold-Formed  
Toothed  
Anchor Channels

abZ Z-21.4-741

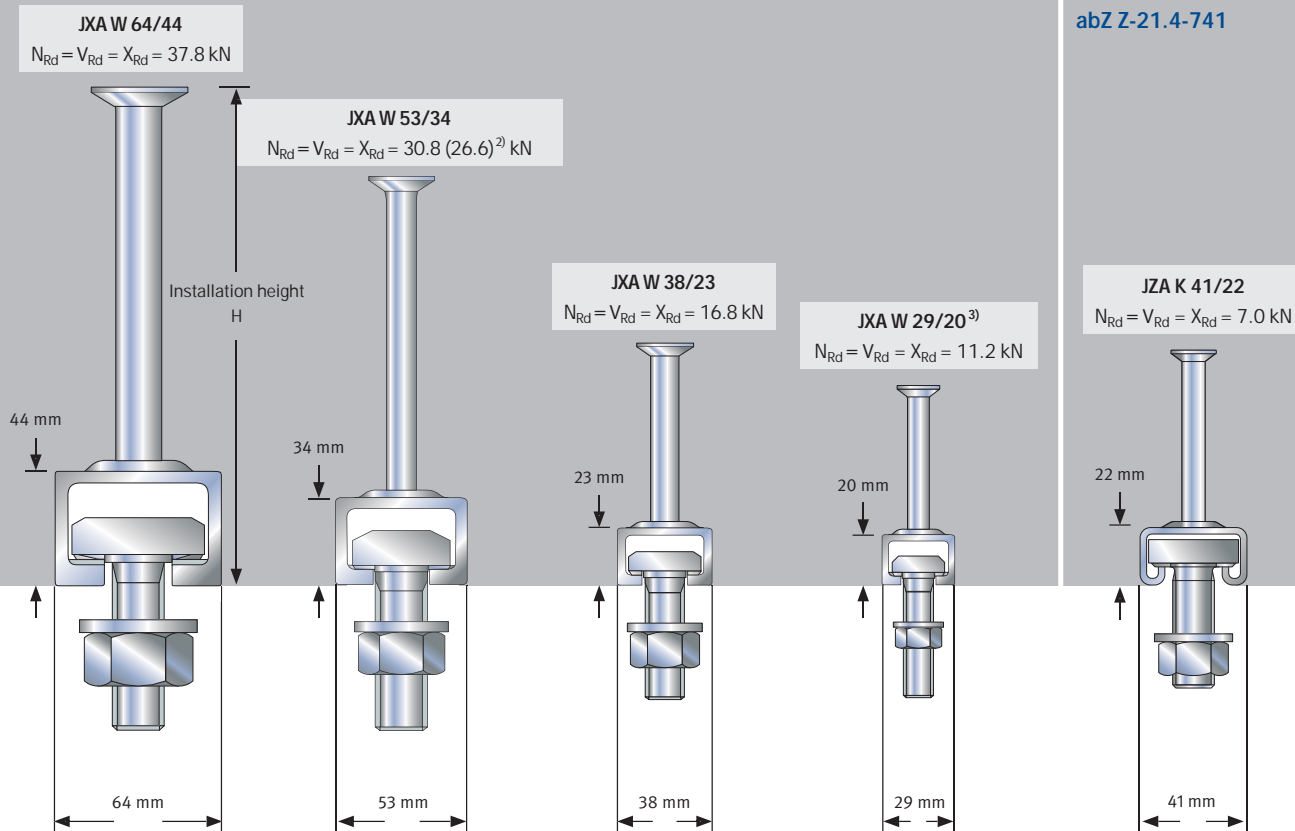
Min. Edge Distance  $c_{min}$  [mm]<sup>4)</sup>

250

200

150

100

75

## Installation Height H [mm]

190

170

100

85

90

## Toothed T-Bolts

JXE	JXB	JXH	JXD	JZS
M 20	M 16	M 12	M 10	M 12
M 24	M 20	M 16	M 12	M 16

 $N_{Rd}$  = design value of the tension load $V_{Rd}$  = design value of the shear load $X_{Rd}$  = design value of the longitudinal load

# Anchor Channels JXA-PC

## Profile Overview<sup>1)</sup>



### Hot-Rolled Toothed Anchor Channels

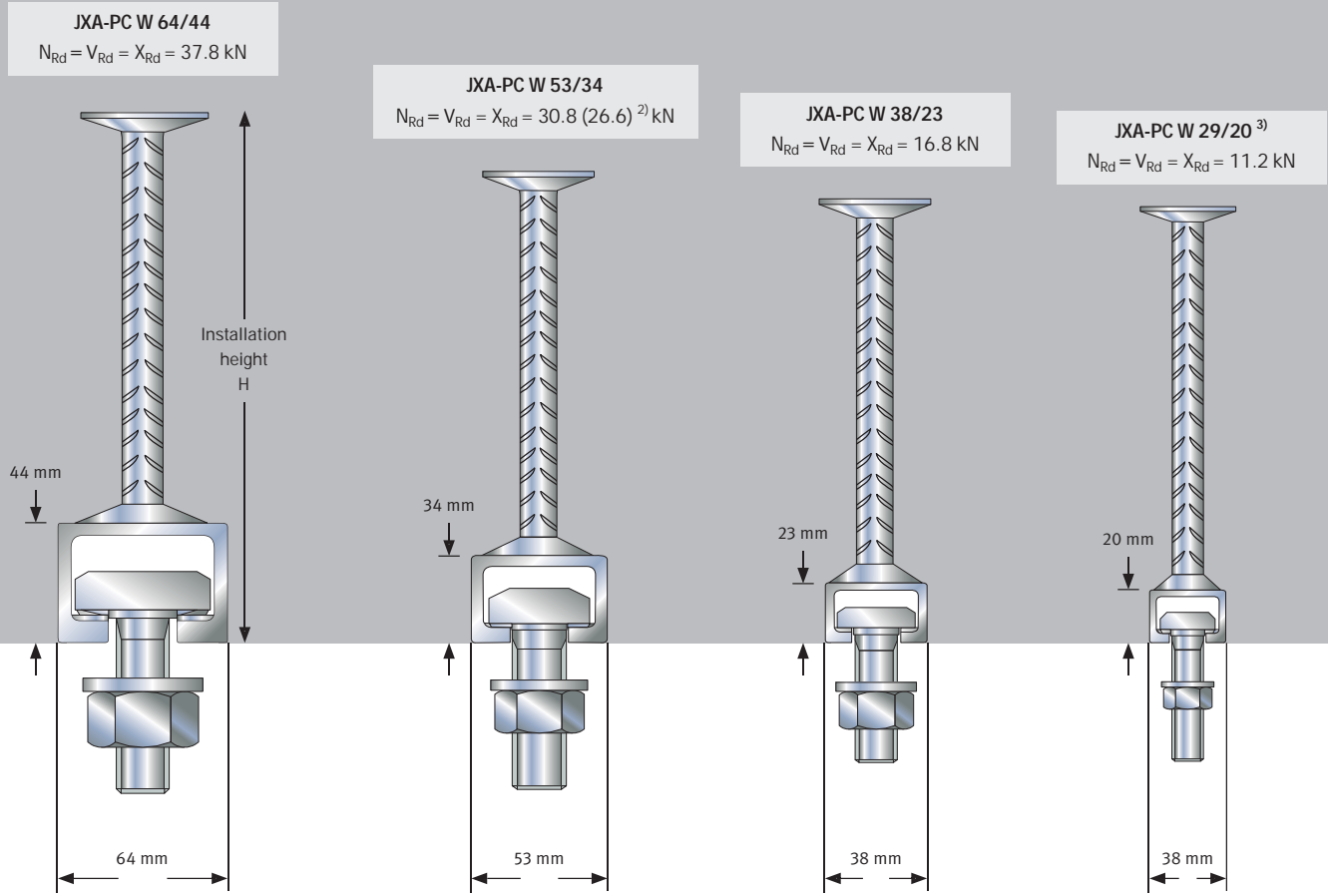

Min. Edge Distance $c_{min}$ [mm] <sup>4)</sup>			
250	200	150	100

Installation Height H [mm]			
200	180	170	165

#### Toothed T-Bolts

JXE	JXB	JXH	JXD
M 20	M 16	M 12	M 10
M 24	M 20	M 16	M 12

**Profile Material and Design**

- Hot-dip galvanised steel (HDG)
- Stainless steel (A4)
- Standard filling: polyethylene (PE) or polystyrene (PS)

**T-Bolt Material and Design**

- Zinc electroplated (ZP) or hot-dip galvanised steel (HDG)
- Stainless steel (A4, F4)

<sup>1)</sup> Profile dimensions can exhibit tolerances.  
<sup>2)</sup> For profiles made of A4 = 26.6 kN.  
<sup>3)</sup> Only in hot-dip galvanised steel (HDG).

<sup>4)</sup> If minimum distances are used, the load-bearing capacities may be reduced, because the load-bearing capacity of the concrete is the controlling variable.

## Toothed Anchor Channels JXA, JZA, and JXA-PC

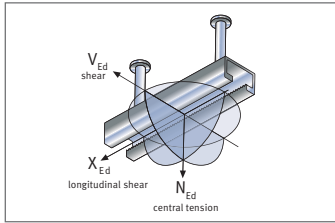
Design resistances for all concrete strength grades  $\geq$  C 20/25<sup>1)</sup>

$$\sqrt{N_{Ed}^2 + V_{Ed}^2 + X_{Ed}^2} \leq F_{Rd}^{3)}$$

Figure a) JZA, JXA  
single load (for all load directions)

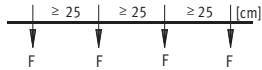

Figure b) JZA (for longitudinal tension,  
shear and central tension)  
load pairs

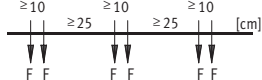

Figure c) JZA (parallel to the  
longitudinal channel axis)  
load pairs

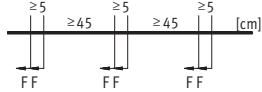
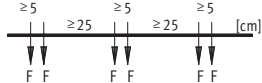

Figure d) JXA (for longitudinal tension,  
shear and central tension)  
load pairs



Profile JXA JXA-PC/ JZA	Corresponding T-Bolt		Design Resistance $F_{Rd}$ [kN] <sup>2) 3)</sup> in All Load Directions		
	Hammer-Head T-Bolts <sup>4)</sup>	Toothed T-Bolts	Unit Load	Load Pairs	
	Profile Length [mm]		$\geq 100$	$\geq 200$	
	Load Spacing [mm]		$\geq 250$	$\geq 50$	$\geq 150$
W 29/20	JD M 12	JXD M 10	11.2	6.3 <sup>5)</sup>	9.0 <sup>5)</sup>
		JXD M 12			
W 38/23	JH M 16	JXH M 12	16.8	9.4 <sup>5)</sup>	12.0 <sup>5)</sup>
		JXH M 16			
W 53/34	-	JXB M 16	30.8 (26.6) <sup>6)</sup>	-	19.25 <sup>7)</sup>
		JXB M 20			
W 64/44	-	JXE M 20	37.8	-	22.4 <sup>7)</sup>
		JXE M 24			
K 41/22	-	JZS M 12	7.0	4.9	4.9
		JZS M 16			

<sup>1)</sup> When anchoring in concrete with the strength grade C 12/15, the permitted loads for C 20/25 must be reduced by a factor of 0.7 and in lightweight concrete with closed structure  $\geq$  LC 25/28 by a factor of 2/3.

<sup>2)</sup> At minimum load spacings shown in table below.

<sup>3)</sup> In the event of simultaneous stressing in different directions the resultant load must not exceed the design load.

<sup>4)</sup> Must not be used for loads in the longitudinal direction (x-x).

See German Technical Approval Z-21.4-1690.

<sup>5)</sup> Intermediate values may be interpolated.

<sup>6)</sup> The value in brackets applies to profiles from A4.

<sup>7)</sup> The minimum load spacing for profile W 53/34 and W 64/44 is 100 mm.

Minimum dimensions for all concrete strength grades<sup>1)</sup>

Profile	$a_r$	$a_a$	$a_e$	$a_f$	$b$ <sup>2)</sup>	Channel Pairs <sup>4)</sup>	
						$a_{r1}$	$a_{a1}$
[mm]							
JXA W 29/20	100	200	80	200	200	140	125
JXA W 38/23	150	300	130	250	300	225	150
JXA W 53/34	200	400	175	350	400	-	-
JXA W 64/44	250	500	225	450	500	-	-
JXA-PC 29/20	100	200	80	200	200	140	125
JXA-PC 38/23	150	300	130	250	300	225	150
JXA-PC 53/34	200	400	175	350	400	-	-
JXA-PC 64/44	250	500	225	450	500	-	-
JZA K 41/22	75	150	80	200	150	100	100

<sup>1)</sup> The minimum dimensions specified in the table apply to reinforced concrete. If the dimensions are increased by 30 %, there is no requirement for reinforcement.

<sup>2)</sup> Applies when a channel is used.

<sup>3)</sup> Results from the installation height of the anchor channel and the required concrete cover according to DIN 1045-1:2008-08 or DIN EN 1992-1-1:2011-01 with DIN EN 1992-1-1/NA:2011-01, Section 4.4.

<sup>4)</sup> Permissible only for central tension.

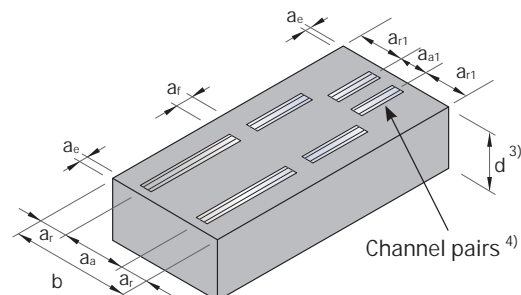

## Anchor Channels JXA-PC

### Channel features

JORDAHL® anchor channels JXA-PC comprise of hot-rolled toothed channel profiles with large-headed ribbed anchors.

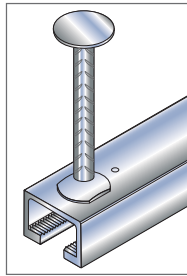

### Requirements for safety-related applications

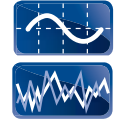
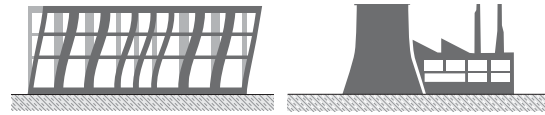

Under the extreme conditions of an earthquake or explosion it is essential that safety-related components continue to function. The effects of such events require the use of special anchors. The suitability of the JXA-PC anchor channel has been tested in seismic and shock tests in 1.5 mm-wide concrete cracks. The large anchor head and the toothed lips ensure very secure and reliable anchoring, even under extreme conditions.

### Advantages of toothed anchor channels JXA-PC

- Proven for shock, fatigue, and dynamic loads
- Suitable to safety-related applications (e.g., power stations)
- Universal load-bearing capacity in all directions
- High resistance to seismic impact
- Fire prevention for up to 90 minutes
- Increased load capacity due to special anchor geometry
- High level of corrosion protection thanks to hot-dip galvanised surface

### Extreme loads can be caused by:

- Earthquake
- Flood
- Explosion
- Fire
- Plane crash, etc.

### Anchor head and shaft

- Large anchor head guarantees reliable grip, even in large cracks
- Additional anchor length and ribbed surface facilitates optimal anchoring in concrete

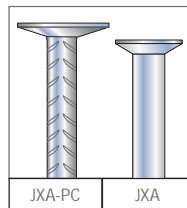

### Anchor foot

- Circular weld allows even load flow between anchor and profile

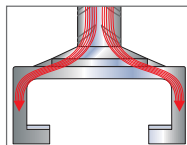

### Toothed W-profile

- Hot-rolled profile for high tightening torques
- Toothed channel lips, together with the matching toothed bolts, ensure high load-bearing capacity in the longitudinal direction of the channels even in the case of an earthquake

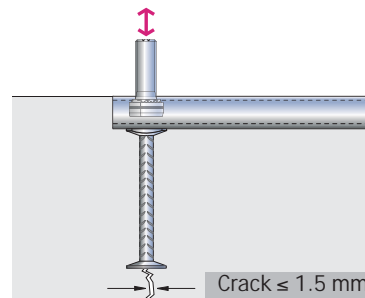
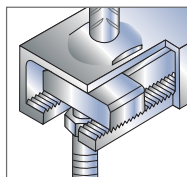

JXA-PC: maximum reliability for high loads and large cracks.



### JORDAHL Information

For further information about "Anchor channels in power plants", see our "JORDAHL Products for Power Plants" brochure at [www.jordahl.de](http://www.jordahl.de) → Downloads → Brochures → Product solutions.

# JORDAHL® Anchor Channels

## JTA-CE, JXA, and JZA Product Range

JTA W 72/48 JTA K 72/48 JTA W 55/42 <sup>1)</sup>		JXA W 64/44 JXA W 53/34 JXA W 38/23		JTA W 53/34		JTA W50+ <sup>1)</sup> JTA W50/30 JTA W40+ <sup>1)</sup> JTA W40/22		JTA K 53/34 JTA K 50/30 JTA K 40/25 JTA K 41/22		JTA K 38/17 JTA K 28/15 JTA W 29/20 <sup>1)</sup>	
Length [mm]	Number of Anchors	Length [mm]	Number of Anchors	Length [mm]	Number of Anchors	Length [mm]	Number of Anchors	Length [mm]	Number of Anchors	Length [mm]	Number of Anchors
150	2	150	2	150	2	150	2	150	2	100	2
200	2	200	2	200	2	200	2	200	2	150	2
250	2	250	2	250	2	250	2	250	2	200	2
300	2	300	2	300	2	300	2	300	2	250	2
350	2	350	3	350	3	350	3	350	3	300	3
400	3	400	3	400	3	400	3	400	3	350	3
550	3	550	3	450	3	550	3	550	3	450	3
800	4	800	4	550	3	800	4	800	4	550	4
900	4	1050	5	800	4	1050	5	1050	5	800	5
1050	5	6000	25	1050	5	1300 <sup>1)</sup>	6	3000	13	1050	6
6000	21			3000	13	1550 <sup>1)</sup>	7	6000	25	3000	16
				6000	25	1800 <sup>1)</sup>	8			6000	31
						2050 <sup>1)</sup>	9				
						2300 <sup>1)</sup>	10				
						2550 <sup>1)</sup>	11				
						3000 <sup>1)</sup>	13				
						6000	25				

Anchor distance ≤ 300 mm	Anchor distance ≤ 250 mm	Anchor distance ≤ 250 mm	Anchor distance ≤ 250 mm	Anchor distance ≤ 250 mm	Anchor distance ≤ 200 mm
--------------------------	--------------------------	--------------------------	--------------------------	--------------------------	--------------------------

<sup>1)</sup> Only in hot-dip galvanised steel (HDG).  
Other lengths on request.



JTA W 53/34 - 550-3A-HDG-CE.

### Profile Material and Design

- Hot-dip galvanised steel (HDG)
- Stainless steel (A4)
- Standard filling: polyethylene (PE) or polystyrene (PS)

### Ordering Example JORDAHL® Anchor Channels JTA-CE

Type	Profile Size	Channel Length [mm]	Anchor	Design	ETA Compliant
JTA W	53/34	– 550	– 3A	– HDG	– CE

### Ordering Example JORDAHL® Anchor Channels JXA

Type	Profile Size	Channel Length [mm]	Material
JXA W	38/23	– 250	– HDG



## Fire Exposure

JORDAHL® anchor channels JTA-CE and JXA can also be used in components made of standard concrete with a fire prevention requirement R60, R90, and R120 according to EC2 (DIN

EN 1992-1-2). In this case, only static loads at right angles to the channel longitudinal axis and central tension/diagonal pull and shear load are permissible (no longitudinal load).

Required concrete cover  $a^3$  [mm] and edge distance  $c_{min,fl}^4$  for fire resistance R60, R90, and R120 for JORDAHL® anchor channels JTA and JXA

	Profile		a [mm]			$c_{min,fl}$
			60 minutes	90 minutes	120 minutes	
	JTA-CE <sup>1)</sup>	K 28/15 K 38/17	35	45	60	$\geq 2.0 \text{ hv}$ $\geq 300 \text{ mm}^4$
		W 40+ W 40/22 K 40/25	35	45	60	
		W 50+ W 50/30 K 50/30	35	45	60	
		W 53/34 K 53/34	50	50	65	
		W 55/42 W 72/48 K 72/48	50	50	70	
JXA <sup>2)</sup> JXA-PC	W 29/20	35	45	–	$\geq 2.5 \text{ hv}$ $\geq 300 \text{ mm}$	
	W 38/23	35	45	–		
	W 53/34	50	50	–		
	W 64/44	50	50	–		

Reinforced concrete slabs of normal concrete with cast JORDAHL® anchor channels.

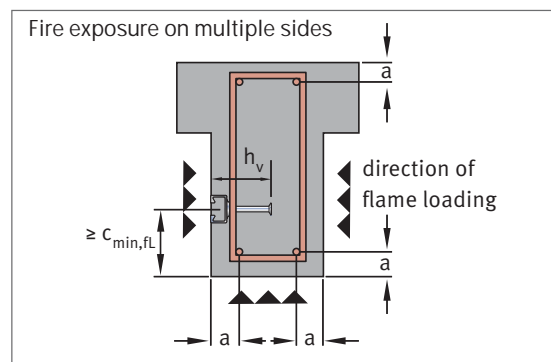
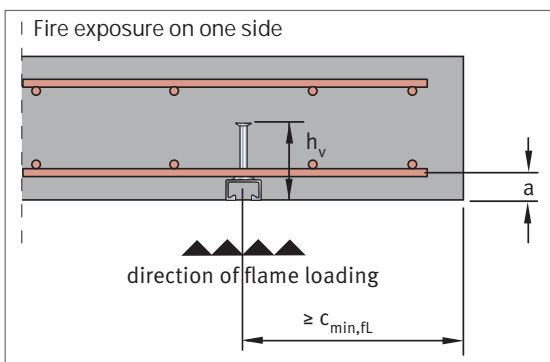

<sup>1)</sup> For further information, see ETA-09/0338 and Z-21.4-151.

<sup>2)</sup> For further information, see Z-21.4-1690.

<sup>3)</sup> Concrete cover a (ETA-09/0338, Annex 18) is equivalent to axial spacing u (German Technical Approval No. Z-21.4-1690, Annex 10 ff.).

<sup>4)</sup> Only for fire exposure on multiple sides.



### JORDAHL Downloads

To design JORDAHL® anchor channels JTA-CE according to ETA-09/0338 and TR 020 and take into account the steel and concrete failure modes, our easy-to-use JORDAHL® EXPERT software is available to download free of charge at [www.jordahl.de](http://www.jordahl.de) → Downloads → Software.

# JORDAHL® Anchor Channels

## Dynamic Load

Due to their special manufacturing process, hot-rolled JORDAHL® anchor channels JTA W are particularly suitable for supporting fully dynamic or partially dynamic loads.

Economical design is possible for any number of cycles-to-failure, using ETA-09/0338.

### Designing for Fatigue Loads

- Calculations for fatigue load effects are made in accordance with EN 1992-1-1
- (EC2), 6.8.3 in fatigue limit state (FLS)
- To calculate the load range, fatigue effects must be divided into static and cyclic.
- The background combination of static loads is equivalent to the frequent load combination at the serviceability limit state (SLS).
- The cyclic loads must be combined with the worst-case combination of static loads

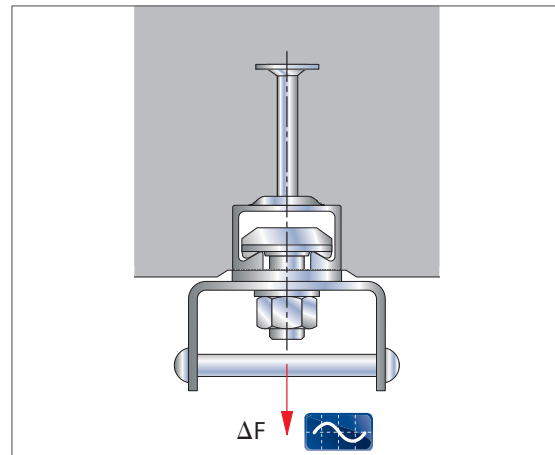

Elevator shaft

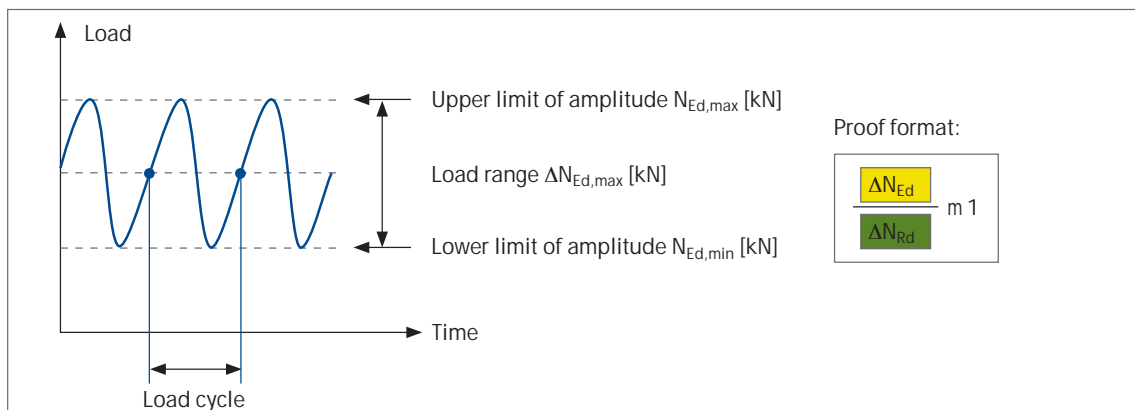

### Fatigue resistance at lower limit of amplitude = 0

The fatigue resistance for loads with a load range where the lower limits of amplitude are equal to zero

can be read directly from the S-N curve according to ETA-09/0338 for any number of load cycles.

#### Fatigue resistance $DN_{Rd,0}$ [kN]

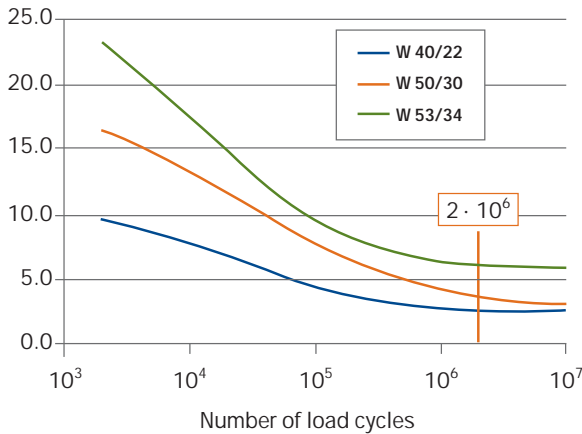

#### Fatigue resistance $DN_{Rd,0}$ [kN]

Profile	Number of Load Cycles		
	10 <sup>6</sup>	2 · 10 <sup>6</sup>	> 10 <sup>7</sup>
JTA W 40/22	2.8	2.7	2.7
JTA W 50/30	4.3	3.7	3.0
JTA W 53/34	6.4	6.1	5.9

### Fatigue resistance at lower limit of amplitude ≥ 0

The fatigue resistance for load ranges where the lower limits of amplitude are greater than zero is derived from

the S-N curve using the Goodman diagram for defined numbers of load cycles.

#### Upper limit of amplitude/load range

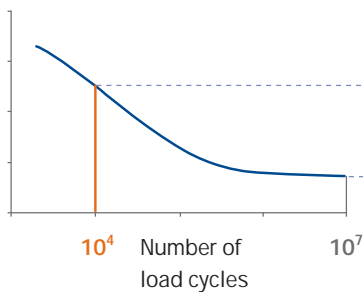

#### Upper limit of amplitude

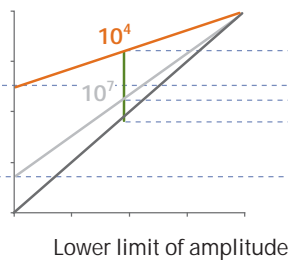

#### Load

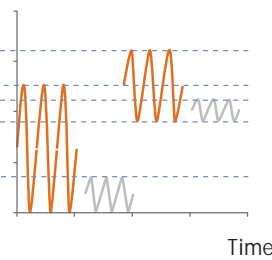

Fatigue resistance at lower limit of amplitude = 0

Fatigue resistance at minimum load \$ 0 (defined number of load cycles)

$$DN_{Rd} = DN_{Rd,0} \cdot \left(1 - \frac{N_{Ed,min}}{N_{Rd}}\right)$$

### Combination of anchor channels and T-bolts for cyclic tensile stress

Profile	Hook-Head T-Bolt		
	Type	Strength	Surface
JTA W 40/22	JC M12	8.8	ZP HDG
	JC M16	4.6 8.8	
JTA W 50/30	JB M16	4.6	
	JB M20	8.8	
JTA W 53/34	JB M16	8.8	
	JB M20		



#### JORDAHL Note

Fatigue load design for profiles JTA W 72/48 and JXA is generated according to the rules in German Technical Approval Z-21.4-151 or Z-21.4-1690. Just contact our technical experts by phone at +49 30 682 83-433 or by email at [experten@jordahl.de](mailto:experten@jordahl.de).

# JORDAHL® Anchor Channels

## Site Use

JORDAHL supplies anchor channels in all required lengths. They are filled with polyethylene (PE) or polystyrene (PS) foam to prevent wet concrete from entering the profile. If using self-compacting concrete and concretes of spread classes F4/F6 (according to

DIN 1045-2), there is a risk that concrete may creep behind the PE filling and contaminate the channel void. In these cases polystyrene (PS) filler is recommended. Both PS and PE foam can be removed with ease after pouring concrete.

### 1. Securing channels in position

Before the concrete is poured, JORDAHL® anchor channels are located according to the reinforcement and formwork drawings. To prevent displacement, the channels are secured:

- for timber formwork (a) by nailing through the nail holes on the rear of the profile,
- by using magnets (b) for steel formwork, or by either gluing with hot-melt adhesive, or alternatively connecting with JORDAHL® T-bolts
- on the top side of a concrete slab, by securely fastening the anchors to the reinforcement or, if necessary, with the aid of special spacers that are attached to the anchors by spot welds.

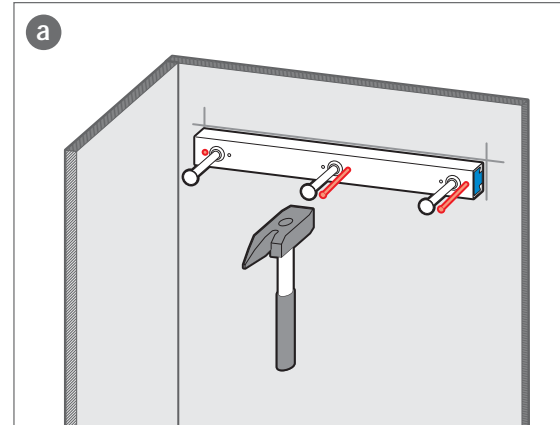

### 2. Concrete

Once the anchor channels have been attached to the formwork, the concrete can be poured. The concrete must be compacted properly around the channel and the anchors.

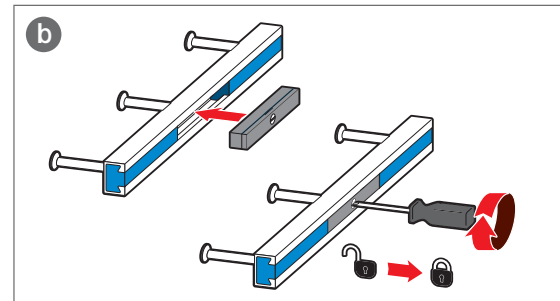

### 3. Removing the foam filling (c)

After the concrete has hardened, the formwork is removed. The anchor channel face should be flush with the concrete. The foam filling can be easily removed with a hammer or another tool.

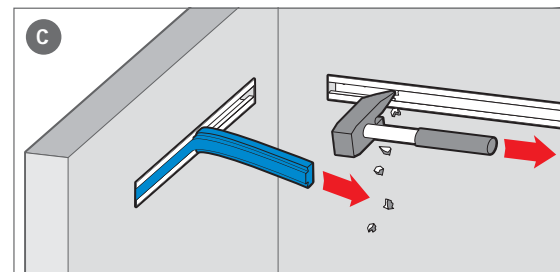

### 4. T-bolt installation (d)

JORDAHL® T-bolts can now be used at any point in the slot of the anchor channel. They are locked by a 90° rotation and tightened to the applicable tightening torque (see table). The notch on the bolt shank must be at a right angle to the direction of the channels (see "Position Identification", p. 49).

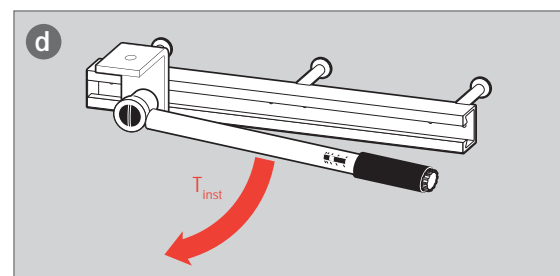

## Installation

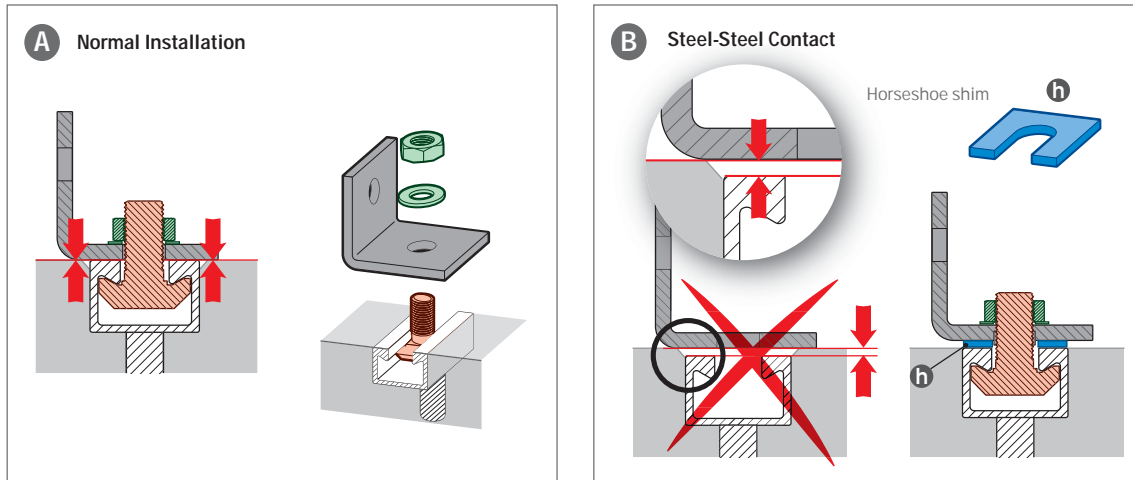

A defined contact must be produced between channel and attached component.

## Tightening Torque [Nm]

Type	T-Bolt	Normal Installation <b>A</b>	Steel-Steel Contact <b>B</b>
		<b>Material</b>	
		4.6, 8.8, A4-50, HC-50, A4-70, HC-70, F4-70, L4-70	8.8, A4-70, HC-70, F4-70, L4-70
			
JD	M6	–	3
JD	M8	8	20
JB, JC, JH, JD	M10	13 <sup>1)</sup> , 15	40
JXD		–	40
JB, JC, JH, JD	M12	15 <sup>1)</sup> , 25	70
JXD, JXH		–	80
JZS		–	50
JB, JC, JH	M16	40 <sup>2)</sup> , 45 <sup>3)</sup> , 60 <sup>4)</sup>	180
JXH		–	120
JXB		–	200
JKB, JKC		–	180
JZS		–	90
JA, JB	M20	75 <sup>5)</sup> , 120	360
JXB, JXE		–	350
JKB		–	360
JA, JB, JE	M24	200	620
JXE		–	450
JA	M27	300	900
JA	M30	380	1200

<sup>1)</sup> JD.

<sup>2)</sup> JH.

<sup>3)</sup> JC.

<sup>4)</sup> JB.

<sup>5)</sup> JB in K 50/30; W 50/30; W 50+.

# JORDAHL® Anchor Channels

## Customised Solutions

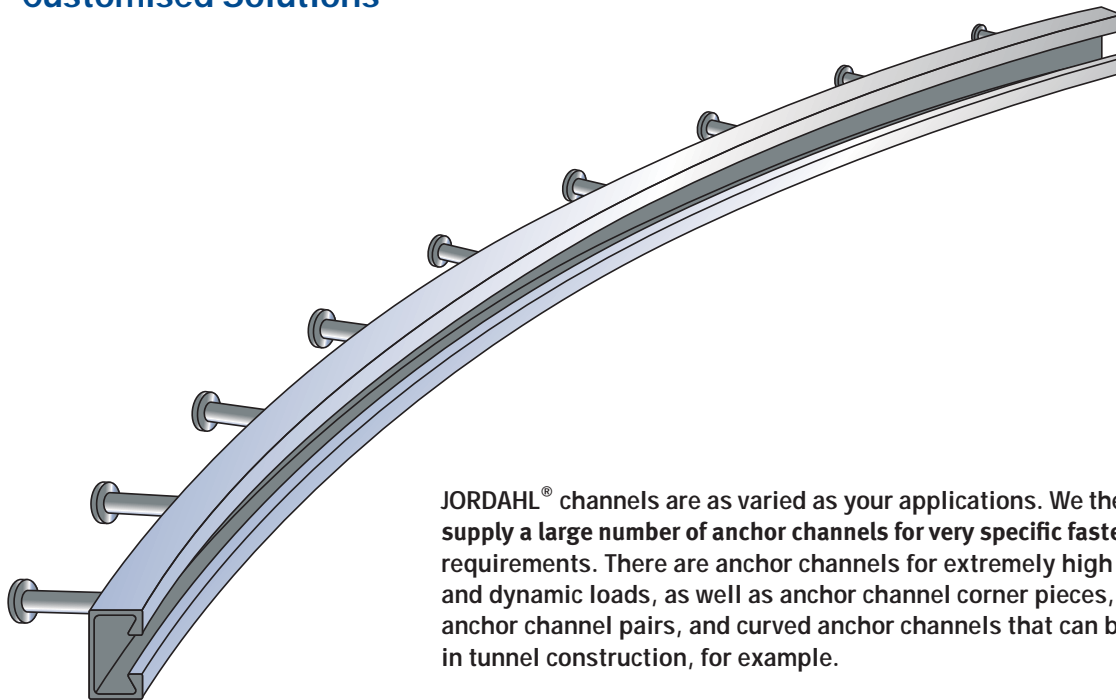

JORDAHL® channels are as varied as your applications. We therefore supply a large number of anchor channels for very specific fastening requirements. There are anchor channels for extremely high static and dynamic loads, as well as anchor channel corner pieces, anchor channel pairs, and curved anchor channels that can be used in tunnel construction, for example.

To fasten handrails and facades, we also supply hot-rolled and cold-formed channels. Channels with welded-on reinforcing bars are suitable for high-transverse loads and reduced edge distances, as well as small concrete depths. With the right T-bolts, our custom solutions provide rapid and secure fastening solutions – even for your very specific applications.

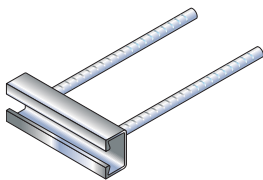

JORDAHL®  
Handrail Connection Channels JGB

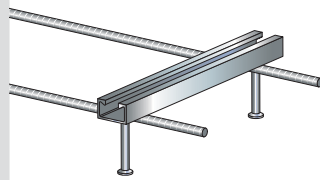

JORDAHL®  
Facade Connection Channels JTA-RT

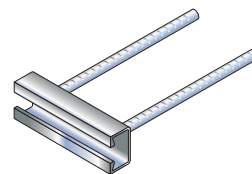

JORDAHL®  
Facade Connection Channels JTA-RF

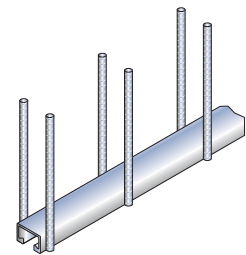

JORDAHL® Anchor Channels JRA

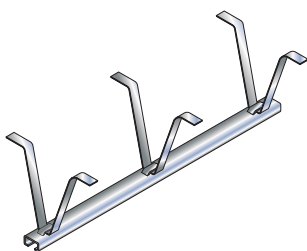

JORDAHL® Anchor Channels JSA

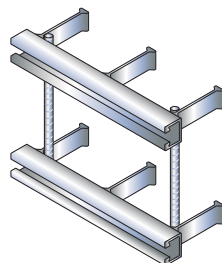

JORDAHL® Anchor Channel Pairs

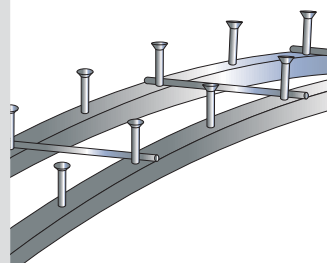

JORDAHL® Curved Anchor Channels

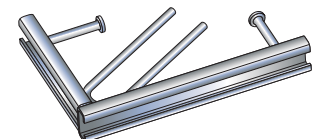

JORDAHL® Anchor Channel Corner Pieces

## Anchor Channel Pairs

Attachment of glass and metal facades is a typical application for anchor channel pairs. JORDAHL® anchor channel pairs are customised for each project. Reinforcing bars are used as spacers.

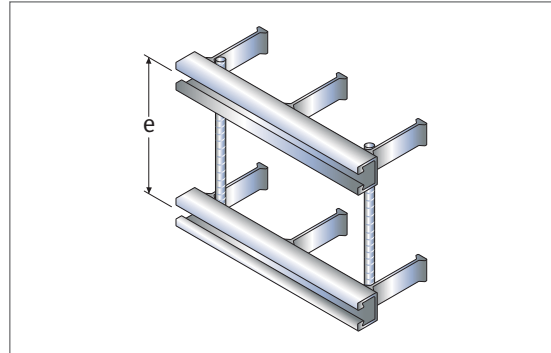

### Ordering Example for Anchor Channel Pairs

Type	Profile	Length [mm]	Anchor	Material	Centre distance of the channels [mm]
JTA	W 53/34	400	3A	HDG	e = 250

## Anchor Channel Corner Pieces

Anchor channel corner pieces are often used to attach brackets for curtain walls. On request, we can also supply special designs.

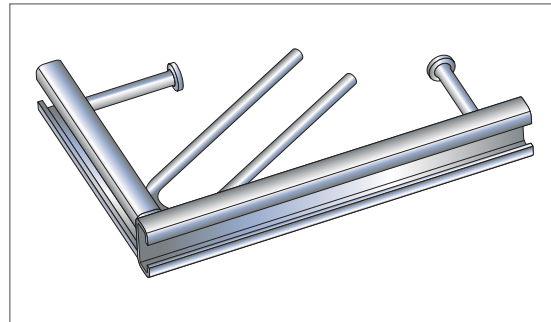

Range	
Profile JTA	Side Length [mm]
K 38/17	125 × 250
	150 × 250
	200 × 200
K 50/30 W 50/30	250 × 250
	300 × 300
K 53/34 W 53/34	250 × 250
	300 × 300

### Ordering Example for Anchor Channel Corner Pieces

Type	Profile	Length [mm]	Material
JTA	K 38/17	125 × 250	A4

## Curved Anchor Channels

JORDAHL supplies curved anchor channels for curved supply shafts, treatment plants, and tunnel construction. The anchor channels can be curved concave (profile slot on inside) or convex (profile slot on outside).

This is executed with high precision, as is the case with anchor channels used for concrete tunnel linings. These channels are checked with gauges specifically for your site.



Curved anchor channels are used around the world to fasten overhead lines in railway tunnels.

## Customised Solutions

### Curved Anchor Channels

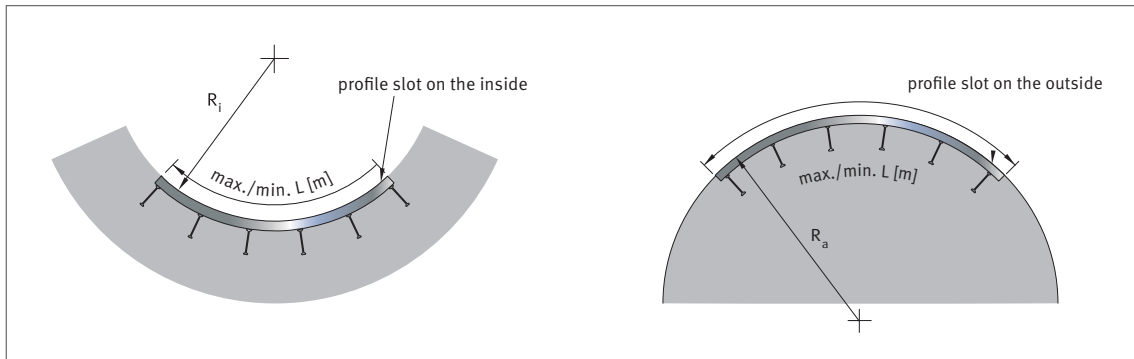

Profile	JTA/JM						JXA/JXM		
	K 72/48 W 72/48	W 55/42	K 53/34 W 53/34	K 50/30 W 50/30 W 50+	K 40/25 W 40/22 W 40+	K 38/17	K 28/15	W 38/23	W 29/20
min $R_i$ [m]	1.0	0.5	0.5	0.5	0.5	0.5	0.5	0.5	0.5
min $R_a$ [m]	3.0	3.0	2.5	2.0	2.0	1.5	1.0	2.0	2.0
min L [m]	1.5	1.5	1.5	1.5	1.0	0.5	0.5	0.5	0.5
max L [m]	5.5	5.5	5.6	5.6	5.6	5.6	5.6	5.6	5.6

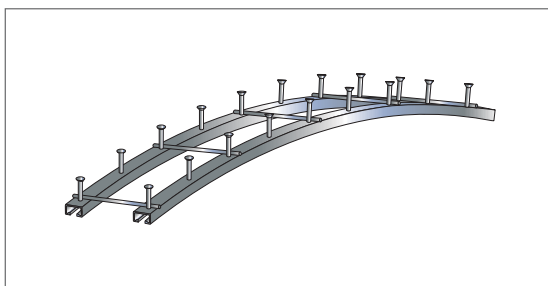

Curved anchor channel pair with welded-on spacers.

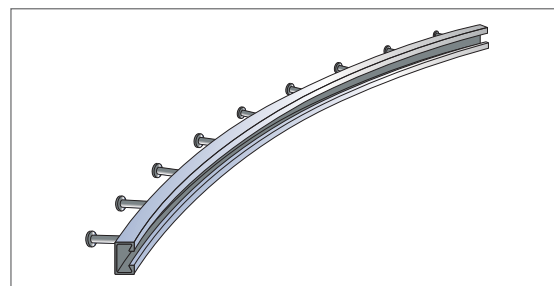

Curved anchor channel for tunnel construction.

#### Ordering Example for Curved Anchor Channels for Tunnel Construction

Type	Profile	Stretched Length [mm]		Anchor	Material	Bending Radius [m]
JTA	W 53/34	–	1050	5A	HDG	$R_i = 4.30$



#### JORDAHL Information

For further information about "Customised solutions", see our "JORDAHL Products for Tunnels" brochure at [www.jordahl.de](http://www.jordahl.de) → Downloads → Brochures → Product Solutions.



## Handrail Connection Channels JGB

JORDAHL® channels JGB provide secure and rapid fastening of handrail posts to the front faces of concrete slabs. The system consists of short anchor

channels with long reinforcing bar anchors that are concreted directly into the balcony slab. Connections are made with the matching JORDAHL® T-bolts.



**JGB K 53/34**  
 $N_{Rd} = V_{Rd} = 30.6 \text{ kN}$

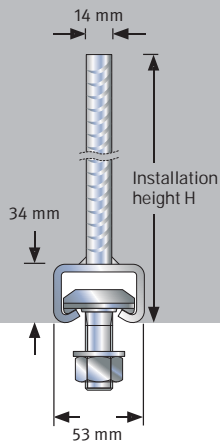

**JGB K 50/30**  
 $N_{Rd} = V_{Rd} = 17.2 \text{ kN}$

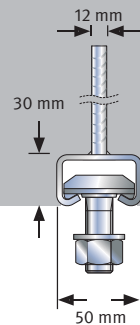

**JGB K 40/25**  
 $N_{Rd} = V_{Rd} = 11.1 \text{ kN}$

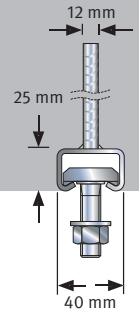

abZ Z-21.4-1913



**JGB K 38/17**  
 $N_{Rd} = V_{Rd} = 10.0 \text{ kN}$

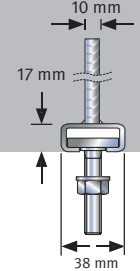

Installation Height H [mm]

320	225	200	165
-----	-----	-----	-----

### T-Bolts

JB	JB	JC	JH
M 16/20	M 12/16/20	M 12/16	M 12/16

### Features

- Hot-rolled or cold-formed anchor channel short pieces with extra-long anchors
- Easy installation and exact adjustment of railing connections
- Suitable for concrete slabs of 10 cm and greater
- Versatile solution for connecting to handrail posts with one or two T-bolts
- Simple, customised application options and reusable fastening
- Easy installation in heavily reinforced elements

### Ordering Example for Handrail Connection Channels

Type	Profile	Length [mm]	Material
JGB	K 38/17-G	200	A4

### Material and Design

- Hot-dip galvanised steel (HDG) for interior applications
- Stainless steel (A4) for exterior applications, with efficient corrosion protection
- Standard filling: polyethylene (PE) or polystyrene (PS)

## Handrail Connection Channels JGB

### JGB product range

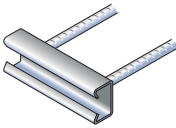
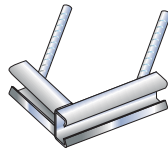
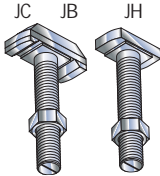
Type	JGB G			JGB G Corners <sup>3)</sup>			Corresponding T-Bolts <sup>4)</sup>
JGB G Anchor with Straight Reinforcing Steel Anchors							
	Dimensions [mm]			Dimensions [mm]			Type x Dimension Material
Profile	Profile Length	Anchor ×	Installation Height H [mm]	Profile Length	Anchor ×	Installation Height H [mm]	
JGB K 38/17-G	100 <sup>1)</sup> 150, 200, 250	10	165	170/170	10	200	JH M 12 × 40 – A4-50/4.6 ZP JH M 16 × 40 – A4-50/4.6 ZP
JGB W 40/22-G JGB K 40/25-G	100 <sup>1)</sup> 150, 200, 250	12	200	170/170	12	240	JC M 12 × 40 – F4-70/8.8 HDG JC M 16 × 40 – F4-70/8.8 HDG
JGB W 50/30-G JGB K 50/30-G	100 <sup>1)</sup> 150, 200, 250	12	225	170/170	12	240	JB M 12 × 40 <sup>2)</sup> – F4-70/8.8 HDG JB M 16 × 50 – F4-70/8.8 HDG JB M 20 × 55 – F4-70/8.8 HDG
JGB W 53/34-G JGB K 53/34-G	100 <sup>1)</sup> 150, 200, 250	14	320	170/170	14	360	JB M 16 × 50 – F4-70/8.8 HDG JB M 20 × 55 – F4-70/8.8 HDG

<sup>1)</sup> Channel lengths available only for fastening with one T-bolt.

<sup>2)</sup> Profile W 50/30 only approved for fastening with two T-bolts.

<sup>3)</sup> Not included in the German Technical Approval.

<sup>4)</sup> When using smaller bolts, the design resistance of the bolts must not exceed the values stipulated in Z-21.4-1913, Annex 8.

### Anchor forms for restricted concrete depths

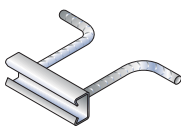
JGB W with Bent Reinforcing Steel Anchors	Profile	Profile Length [mm]	Anchor ×	Installation Height H [mm]
	JGB K 38/17-W	100 – 250	10	120
	JGB K 40/25-W <sup>5)</sup>		12	155
	JGB K 50/30-W <sup>5)</sup>		12	170
	JGB K 53/34-W <sup>5)</sup>		14	240

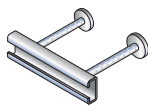
JGB DA with Single Headed Anchors	Profile	Profile Length [mm]	Anchor ×	Installation Height H [mm]
	JGB K 38/17-DA <sup>6)</sup>	100 – 250	10	120
	JGB K 40/25-DA <sup>5)</sup>		10	125
	JGB K 50/30-DA <sup>5)</sup>		12	150
	JGB K 53/34-DA <sup>5)</sup>		14	250

<sup>5)</sup> Available with hot-rolled profile on request. <sup>6)</sup> Only in hot-dip galvanised steel (HDG).



#### JORDAHL Downloads

To plan JORDAHL® handrail connection channels JGB, we supply convenient design software based on the German Technical Approval (Z-21.4.-1913). The software can be downloaded free of charge at [www.jordahl.de](http://www.jordahl.de) → Downloads → Software.

## Facade Connection Channels JTA-RF and JTA-RT

JORDAHL® channels JTA-RF and JTA-RT are designed to transfer high shear and tension loads into thin concrete floor slabs. They are a perfect solution for fastening heavy curtain wall elements that are subjected to high wind loads. JTA-RT channels are used for connections to the top of the floor slab and JTA-RF channels are used

for connections to the front face of slabs. Both types are particularly suitable for conditions where connections must occur close to the edge of the concrete. The length of the channels and the number of anchors can be adjusted to the specific requirements of the project.

### Features

- High load capacities in thin concrete floor slabs
- Connections can be adjusted in the channel parallel to the slab edge for rapid facade installation and to compensate for design tolerances
- Dimensions of attached brackets can be reduced due to small edge distance
- Suitable for tall buildings with extremely high wind loads
- Low installation height helps installation both in top of slab bracket recesses, and also for filigree prestressed concrete slabs
- Hot-rolled channel profiles resist both dynamic wind loads over millions of cycles, and heavy seismic loading



JTA-RT

### Material and Design

- Hot-dip galvanised steel (HDG) for interior applications
- Stainless steel (A4) for exterior applications, with efficient corrosion protection
- Standard filling: polyethylene (PE) or polystyrene (PS)

### JTA-RF product range

JTA-RF Anchor with Straight Steel Reinforcement Anchors	Profile	Profile Length [mm]	Anchor x	Installation Height H [mm]
	JTA-RF W 40/22	150, 300, 350	10	330
	JTA-RF W 50/30		12	340
	JTA-RF W 53/34		14	420

### Ordering Example for Facade Connection Channels

Type	Profile	Length [mm]	Material
JTA-RF	W 50/30	300	A4

## Facade Connection Channels JTA-RF and JTA-RT

### JTA-RT product range

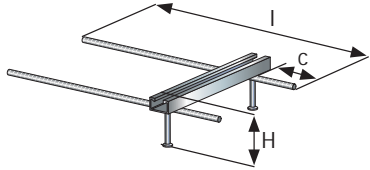
JTA-RT Round Anchor and Steel Reinforcement Anchors	Profile	Variant	Profile Length [mm]	c [mm]	l [mm]
	JTA-RT W 40/22 Installation Height H = 90 mm	1	150–550	50	340
		2		75	365
		3		100	390
		4		125	415
		5		150	440
		6		175	465
		7		200	490
	JTA-RT W 50/30 Installation Height H = 100 mm	1	150–550	75	365
		2		100	390
		3		125	415
		4		150	440
		5		175	465
		6		200	490
	JTA-RT W 53/34 Installation Height H = 170 mm	1	150–550	100	400
		2		125	425
		3		150	450
		4		175	475
		5		200	500

### Ordering Example for JTA-RT

Type	Profile	Variant	Length [mm]	Material
JTA-RT	W 40/22	– 01	– 200	– HDG



#### JORDAHL Downloads

To plan JORDAHL® anchor channels JTA-RF and JTA-RT, we provide convenient and intuitive JORDAHL® EXPERT Design Software. The software can be downloaded free of charge at [www.jordahl.de](http://www.jordahl.de) → Downloads → Software.

## Anchor Channels JSA

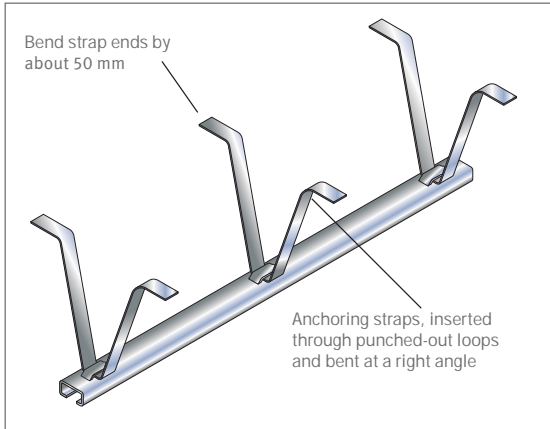

Anchor channel JSA with installed straps.

JORDAHL® anchor channels JSA consist of profiles with punched-out loops and associated anchoring straps made of sheet metal strips which are installed on the building site and can easily be bent to shape by hand.

### Applications

JORDAHL® anchor channel JSA should be used for non-structural connections. Anchoring must always be in normal reinforced concrete in strength grade  $\geq C12/15$ .

### Installation

The anchoring straps must be inserted and bent into shape at no greater than 250 mm spacings (see figure). Loops occur at spacings of 125 mm, so straps are only inserted in every other loop. In addition, anchoring straps must be placed at the first and last loop positions at either end of the channel.

### Delivery Lengths and Anchor Arrangements

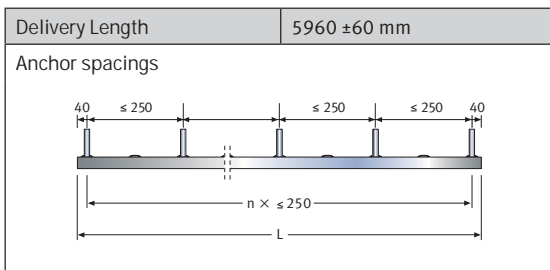

### JORDAHL Advice

Do you have queries regarding load-bearing capacities, spacings, and applications for JORDAHL® anchor channels JSA? Just contact our JORDAHL experts by phone at +49 30 682 83-433 or by email at [experten@jordahl.de](mailto:experten@jordahl.de).

## Profile Types and Technical Details

Profile JSA	Weight <sup>1)</sup> of Channel with Anchor [kg/m]	Means of Fastening		Channel		Anchoring Strap $t \times w \times l$ [mm]
		T-Bolt	Sliding Nut	Material	Finish	
<b>K 38/17</b> 	2.3	JHM10 – 16	JGM H M5 – 12	steel	mill finish, hot-dip galvanised steel	2 × 20 × 400
<b>K 28/15</b> 	1.34	JDM 6 – 12	JGM D M4 – 10	steel	mill finish, hot-dip galvanised steel	1.5 × 15 × 320

<sup>1)</sup> Weights per unit metre for mill finish steel. For galvanised profiles: Weight per metre × 1.10 applies.

### Ordering Example for JSA

Type	Profile	Channel Length [mm]	Material
JSA	K 38/17	5960	HDG

## Anchor Channel JRA W 74/48

### Anchor channels for extremely high static and dynamic loads

$$N_{Rd} = V_{Rd} = 56.0 \text{ kN}$$

$$\Delta F = 30.0 \text{ kN}$$

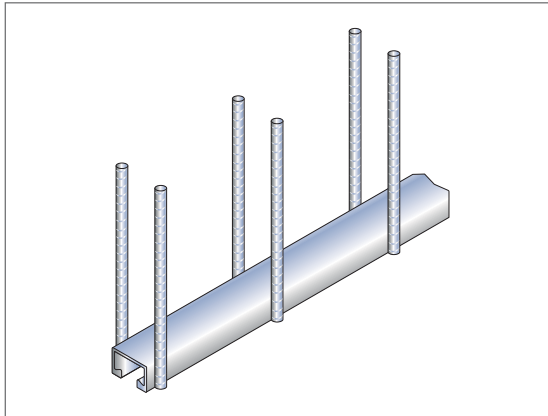

Anchor channel type JRA with reinforcing steel anchors welded on both sides.

JORDAHL® anchor channels JRA consist of **W 74/48** profiles with reinforcing steel anchors welded on the sides. Other profile sizes can also be provided with reinforcing steel anchors.

#### Load capacity

JRA W 74/48 is suitable for absorbing extremely high static and dynamic loads. The design has been tested by the German Federal Institute for Material Testing under number 2.2/20247. On the basis of experimental data with a load range of  $F_o - F_u = 38 \text{ kN}$ , with an overload of  $F_w = 40 \text{ kN}$ , these anchor channels have passed the long-term stress capability test for fatigue load ranges of up to 30 kN.

#### Applications

The system can be used for many different application areas.

- Crane and conveyor systems
- Power plants
- Secure rooms

#### Material

Profile W 74/48		Anchor $s \leq 250 \text{ mm}$		Weight of Channel Including Anchor <sup>1)</sup> [kg/m]
Material	Material	$\times$ [mm]	Material	
steel	hot-dip galvanised $\geq 50 \mu\text{m}$	14	B500B <sup>2)</sup>	14.0

<sup>1)</sup> At anchor length  $L_{\text{total}} = 40 \text{ cm}$ .

<sup>2)</sup> The anchors consist of B500B highly ductile reinforcing steel.

#### Reinforced concrete anchors

#### Anchoring length $l_{bd}$ according to DIN EN 1992-1-1:2011-01

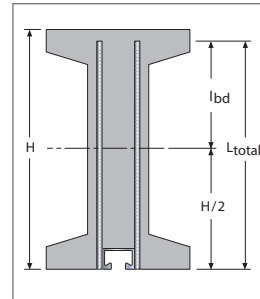

The reinforcing bar anchors must be anchored with anchoring length  $l_{bd}$  in the component compression zone. The anchoring length is calculated from half the component height plus anchoring length  $l_{bd}$  and must be specified with the order.

Concrete	Anchoring Length $l_{bd}$ [cm] B500B, $\times 14$ ; Good Bonding Conditions	
	Straight Rods	Hooks, Angled Hooks
C 20/25	28	19
C 30/37	21	15
C 35/45	19	14

#### Length of the Reinforced Concrete Anchor, Calculation Example

$$L_{\text{total}} = H/2 + l_{bd} \text{ [cm]}$$

Anchor length  $L_{\text{total}}$  = Length from the outer edge of the channel profile as far as the top edge of the reinforced concrete anchor.

Please specify when ordering.

$H$  = Height of the reinforced concrete component

$l_{bd}$  = Anchoring length according to  
DIN EN 1992-1-1:2011-01



#### JORDAHL Note

Reinforcing steel anchors can also be provided to resist high shear loads, if allowed by component dimensions and reinforcement designs.

## Technical Details

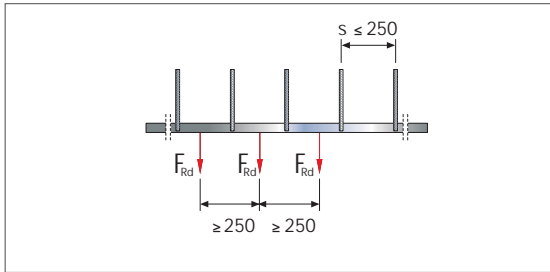

Load arrangement, single load.

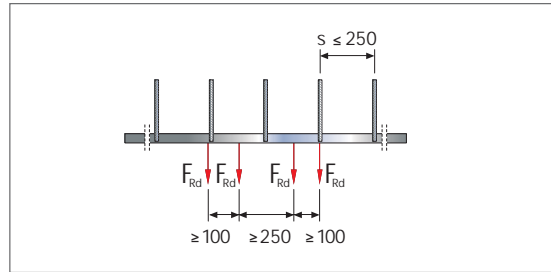

Load arrangement, load pairs.

Permissible  
 $F = \frac{F_{Rd}}{1.4}$

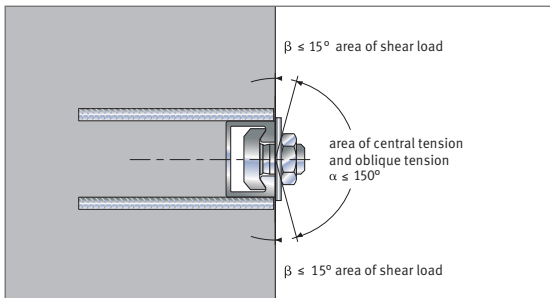

Load ranges.

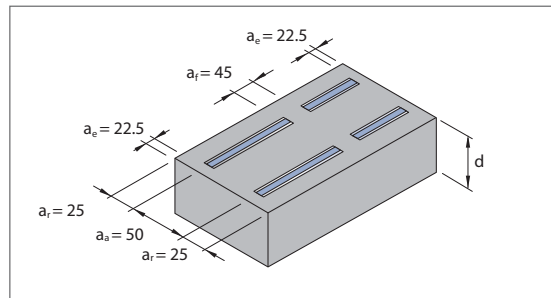

Associated edge distances [cm].

Profile JRA	Recommended Loads $F_{Rd}$ [kN] <sup>1)</sup>				Technical Details of Associated T-Bolts						
	Central tension and diagonal pull $\alpha \leq 150^\circ$		Shear load $\beta \leq 15^\circ$		T-bolts JA x	Tightening torque $M_A$ [Nm]		Bending moment of the T-bolts $M_{Rd}$ [Nm]			
	Unit load	Load pairs	Unit load	Load pairs		Strength grade 4.6		Strength grade 8.8 <sup>2)</sup>			
					M 24	M 30	M 24	M 30	M 24	M 30	
<b>W 74/48</b>	56.0	28.0	44.8	22.4	M 24, M 30	200	400	209.9	419.9	523.9	1059.6

<sup>1)</sup> The application is permissible only in reinforced concrete. When installed in the tension zone of reinforced concrete components, it is necessary to verify the transfer of the loads in the concrete member.

<sup>2)</sup> On request.

### Permissible stress amplitude $\Delta F = F_0 - F_u$ [kN] under repeated tensile stress

In view of the high resistance to cycling of the profile, the limited-dynamic load-bearing capacity of the T-bolts is critical.

Profile JRA	T-Bolt	Strength	Amplitude $\Delta F$
<b>W 74/48</b>	JA M 24	4.6	26
	JA M 30	4.6	26
	JA M 24	8.8	30
	JA M 30	8.8	30

### Ordering Example for JRA Anchor Channel with Anchor $L_{total} = 460$ mm

Type	Profile	Length [mm]	Material	Anchor Length $L_{total}$
JRA	W 74/48	6000	HDG	460

### Delivery lengths

Short pieces in lengths beginning at 150 mm as well as lengths by the metre. Fixed lengths on request.

# JORDAHL® Mounting Channels

## Mounting Channels JM, JXM, and JZM



JORDAHL® mounting channels provide maximum reliability and versatility: Combined with the matching JORDAHL® T-bolts, they create a reliable and adjustable connection that can be adapted at any time to meet new support and fastening requirements. Mounting channels can either be welded or bolted to supporting structures.

### Extensive Benefits

- Quick replacement, refitting, and adjustment of attached components
- Provide economies due to shorter design and installation times of attached components
- Free positioning of connections and variable adjustment by using a simple spanner
- Compensation of construction tolerances; standard grid sizes can be changed
- Fast disassembly of attached components
- Complete 2D and 3D CAD models available to download free of charge



### Powerful Features

- Suitable for medium duty and heavy load applications
- Permit variable bolt spacings in the longitudinal direction of the channel and tolerance compensation for attached components
- Channels available in lengths of up to 6 metres
- Available in mill finish steel (black), hot-dip galvanised steel (HDG), and stainless steel (A4) for efficient corrosion protection
- Curved mounting channels, back-to-back profiles, and cold-formed (perforated) mounting channels available on request





Vehicle construction



Shipbuilding industry



Elevator doors fastened in lattice girder shaft

## Fastening Solutions

- Rail vehicles
- Shipbuilding industry
- Tunnel construction
- Power station construction
- Elevator installation
- Vehicle construction
- Machinery and plant building
- Steel and industrial construction
- Energy and building technology

## Hot-Rolled Mounting Channels JM W and JXM W

- Hot-rolled channels JM W are suitable for tension and shear loads at right angles to the channel axis
- Hot-rolled toothed channel JXM W are also suitable for tension and shear loads at right angles to the channel axis, but also offer enhanced load capacity in the longitudinal direction of the channel
- Hot-rolled from a single block and free from residual stresses
- Highly ductile material suitable for welding and high dynamic loading
- JXM W channels allow design incorporating universal load-bearing capacity in all directions



JM W



JXM W

## Cold-Formed Mounting Channels JM K, JZM, and JML

- Cold-formed channels JM K are suitable for loads consisting of pull and shear load at right angles to the channel axis
- Cold-formed toothed channels JZM are also suitable for loads consisting of pull and shear load at right angles to the channel and offer enhanced load capacity in the longitudinal direction of the channel
- Cold-formed perforated channels JML K can be through-bolted to the structure
- Cold-formed constant material thickness
- Suitable for regular static loads but not dynamic applications
- Low weight and good load capacity
- Typically used for easy fastening of mechanical and electrical services, such as cable trays and air-conditioning ducts



JM K



JML K



JZML K

# JORDAHL® Mounting Channels

## Hot-Rolled Mounting Channels (hot-rolled profiles)

JM W hot-rolled profile mounting channels have the following exceptional features:

- Thickened channel lips with large contact areas that allow high T-bolt tightening torques
- Right-angled profile edges with low residual stresses enable good weldability

### Material and Design

- black = mill finish
- HDG = hot-dip galvanised steel
- A4 = stainless steel 1.4401/1.4404/1.4571



### Mounting Channels JM W<sup>3)</sup>

	<b>Profile JM W 72/48<sup>1)</sup></b> black, HDG, A4 T-bolt JA M 20 – 30 Sliding nut JGM A M 20
	<b>Profile JM W 55/42<sup>2)</sup></b> black, HDG T-bolt JB M 10 – 24 Sliding nut JGM B M 6 – 16
	<b>Profile JM W 53/34</b> black, HDG, A4 T-bolt JB M 10 – 20 Sliding nut JGM B M 6 – 16
	<b>Profile JM W 50/30</b> black, HDG, A4 T-bolt JB M 10 – 20 Sliding nut JGM B M 6 – 16
	<b>Profile JM W 40/22</b> black, HDG, A4 T-bolt JC M 10 – 16 Sliding nut JGM B M 6 – 16

### Toothed Mounting Channels JXM W<sup>3)</sup>

	<b>Profile JXM W 64/44</b> black, HDG Toothed T-bolt JXE M 20 – 24
	<b>Profile JXM W 53/34</b> black, HDG, A4 Toothed T-bolt JXB M 16 – 20
	<b>Profile JXM W 41/27</b> black, HDG Toothed T-bolt JXH M 12 – 16
	<b>Profile JXM W 38/23</b> black, HDG, A4 Toothed T-bolt JXH M 12 – 16 Hammer-head T-bolt JH M 16
	<b>Profile JXM W 29/20</b> black, HDG Toothed T-bolt JXD M 12 Hammer-head T-bolt JD M 12

<sup>1)</sup> JM W 72/48 is equivalent to JM W 74/48.

<sup>2)</sup> JM W 55/42 is equivalent to JM W 54/43.

<sup>3)</sup> Profile dimensions can exhibit tolerances.

### Ordering Example for Mounting Channel JM

Type	Profile	Channel Length [mm]	Material
JM	W 50/30	– 6000	– HDG

## Welded or Bolted Attachment of Mounting Channels

### Factored resistance per load point

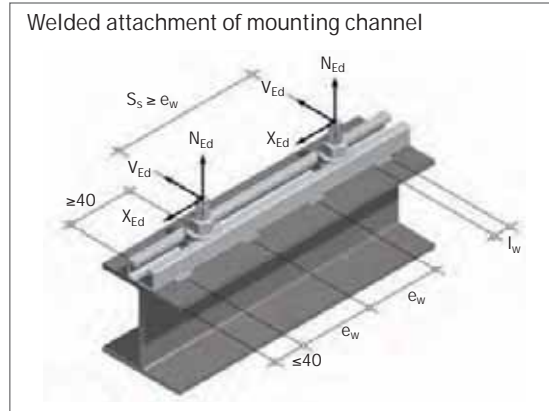
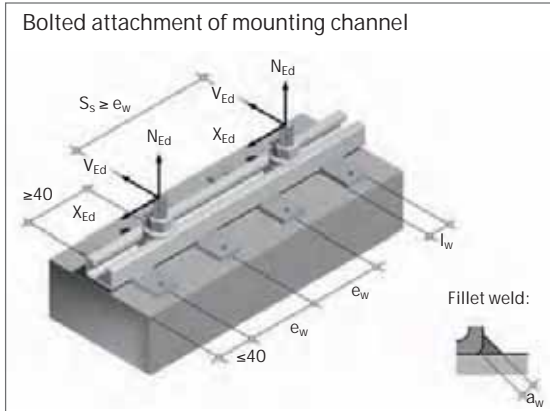

Profile	Welds			Factored Resistance per Load Point <sup>1)</sup>			T-Bolts	
	a <sub>w</sub> [mm]	l <sub>w</sub> [mm]	e <sub>w</sub> [mm]	N <sub>Rd</sub> [kN]	V <sub>Rd</sub> [kN]	X <sub>Rd</sub> [kN]	Type	min. spacing S <sub>s</sub> [mm]
JM W 72/48	5	50	300	65.8	24.0	–	JA M24	300
JM W 55/42	4	30	250	54.0	24.0	–	JB M20	250
JM W 53/34	4	30	200	36.3	20.9	–	JB M20	200
JM W 50/30	4	30	200	20.2	14.0	–	JB M20	200
JM W 40/22	3	30	150	11.4	6.6	–	JC M16	150
JXM W 64/44	5	40	250	53.3	17.4	37.8	JXE M24	250
JXM W 53/34	4	30	200	43.3	13.1	30.8/26.6 <sup>2)</sup>	JXB M20	200
JXM W 41/27	4	30	200	25.0	6.2	16.8	JXH M16	200
JXM W 38/23	4	30	200	18.0	5.9	16.8	JXH M16	200
JXM W 29/20	3	30	150	10.9	2.0	11.2	JXD M12	150

<sup>1)</sup> • For simultaneous load in all load directions, the following relationship must be verified:

$$N_{Ed}/N_{Rd} + V_{Ed}/V_{Rd} + X_{Ed}/X_{Rd} \leq 1$$

X<sub>Ed</sub>, V<sub>Ed</sub>, N<sub>Ed</sub>: Design loads

X<sub>Rd</sub>, V<sub>Rd</sub>, N<sub>Rd</sub>: Design resistances

- The factored resistance capacities apply to load application at the channel lip. If the load, e.g., for stand-off installation, is introduced at a distance from the channel lip, the bolt bending moments must be taken into account and must be superimposed on the tensile load component.
- The factored resistance of the T-bolt and of the channel profile need to be considered. The lower value is applicable in each case.
- For maximum factored resistance in shear, the tightening torques must be applied, depending on bolt size and bolt strength, as per pages 52, 53, 55, and 29.

<sup>2)</sup> Value applies to stainless steel.



#### JORDAHL Information

Do you want to find out more about JORDAHL mounting technology products? Take a look at our "JORDAHL® Systems for Mounting Technology" catalogue at [www.jordahl.de](http://www.jordahl.de) → Downloads → Brochures or simply scan the QR code.



## Cold-Formed Mounting Channels (cold-formed profiles)

### Mounting Channels JM K<sup>1)</sup>

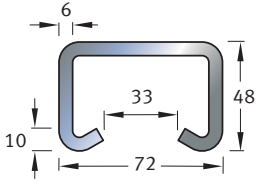
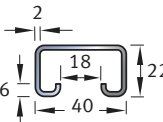
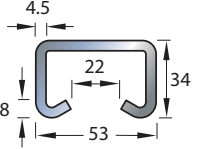
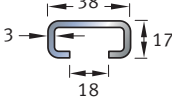
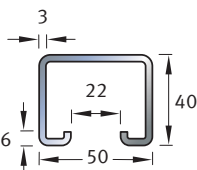
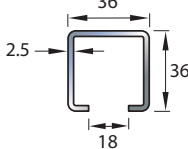
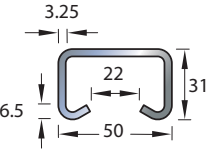
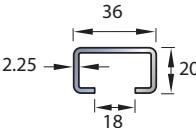
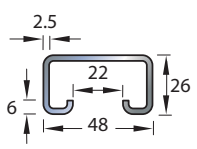
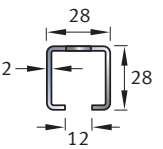
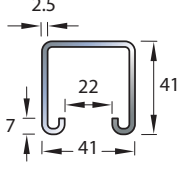
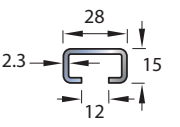
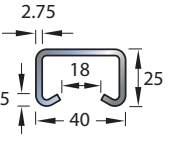
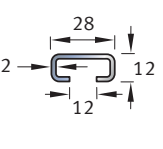
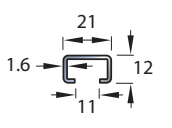
	<b>JM K 72/48</b> black, HDG, A4 T-bolt JAM 20 – 30 Sliding nut JGM A M 20		<b>JM K 40/22</b> black, HDG T-bolt JC M 10 – 16 Sliding nut JGM C M 6 – 16
	<b>JM K 53/34</b> black, HDG, A4 T-bolt JB M 10 – 20 Sliding nut JGM B M 6 – 16		<b>JM K 38/17</b> black, HDG, A4 T-bolt JH M 10 – 16 Sliding nut JGM H M 5 – 12
	<b>JM K 50/40</b> black, HDG T-bolt JB M 10 – 20 Sliding nut JGM B M 6 – 16		<b>JM K 36/36</b> black, HDG, A4 T-bolt JH M 10 – 16 Sliding nut JGM H M 5 – 12
	<b>JM K 50/30</b> black, HDG, A4 T-bolt JB M 10 – 20 Sliding nut JGM B M 6 – 16		<b>JM K 36/20</b> black, HDG T-bolt JH M 10 – 16 Sliding nut JGM H M 5 – 12
	<b>JM K 48/26</b> black, HDG T-bolt JB M 10 – 20 Sliding nut JGM B M 6 – 16		<b>JM K 28/28</b> black, HDG, A4 T-bolt JD M 6 – 12 Sliding nut JGM D M 4 – 10
	<b>JM K 41/41</b> black, HDG Channel nuts JAM 22 M 6 – 12 JAM 22 F M 6 – 12		<b>JM K 28/15</b> black, HDG, A4 T-bolt JD M 6 – 12 Sliding nut JGM D M 4 – 10
	<b>JM K 40/25</b> black, HDG, A4 T-bolt JC M 10 – 16 Sliding nut JGM C M 6 – 16		<b>JM K 28/12</b> black, HDG, A4 T-bolt JD M 6 – 10 Sliding nut JGM D M 4 – 10
			<b>JM K 21/12</b> black T-bolt JG M 6 – 8 Sliding nut JGM G M 4 – 8

<sup>1)</sup> Profile dimensions can exhibit tolerances.

## Toothed Mounting Channels JZM K<sup>1)</sup>

	<b>JZM K 41/22</b>
	black, HDG, A4 Toothed T-bolts JZS M 12-16

## Slotted-Back Mounting Channels (perforated profiles) JML K<sup>1)</sup>

	<b>JML K 50/40</b>
	black, HDG LL 11 x 40 T-bolt JB M 10-20 Sliding nut JGM B M 6-16
	<b>JML K 41/41</b>
	black, HDG LL 11 x 40 Channel nuts JAM 22 M 6-12 JAM 22 F M 6-12
	<b>JML K 40/25</b>
	black, HDG, A4 LL 11 x 40 T-bolt JC M 10-16 Sliding nut JGM C M 6-16
	<b>JML K 36/36</b>
	black, HDG, A4 LL 11 x 40 T-bolt JH M 10-16 Sliding nut JGM H M 5-12
	<b>JML K 28/28</b>
	black, HDG, A4 LL 11 x 40 T-bolt JD M 6-12 Sliding nut JGM D M 4-10
	<b>JML K 28/15</b>
	black, HDG, A4 LL 9 x 25 T-bolt JD M 6-12 Sliding nut JGM D M 4-10
	<b>JZML K 41/22</b>
	black, HDG, A4 LL 11 x 40 Toothed T-bolt JZS M 12-16



Cold-formed JORDAHL® mounting channels can be used for a multitude of static loading conditions, e.g., to fasten pipes, cables, etc.

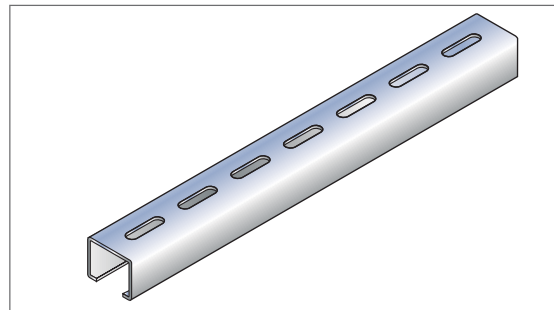

### Slotted-back mounting channels

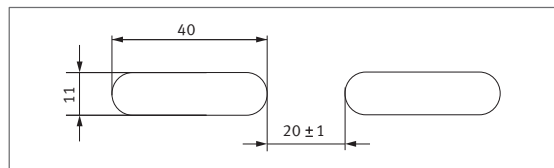

Standard slot pattern 11 x 40

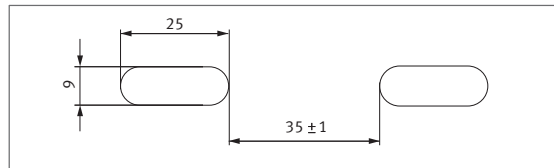

Standard slot pattern 9 x 25

### Material and Design

- black = mill finish
- HDG = hot-dip galvanised steel
- A2 = stainless steel 1.4301/1.4541
- A4 = stainless steel 1.4401/1.4404/1.4571

### Ordering Example for Slotted-Back Mounting Channel JML K

Type	Profile	Channel length [mm]	Material
JML	K 28/15	6000	HDG

# JORDAHL® Mounting Channels

## Technical Details

### Weight, Cross Sections, Moments of Inertia and Resistance, Factored Resistance per Load Point

Permissible

$$F = \frac{F_{Rd}}{1.4}$$

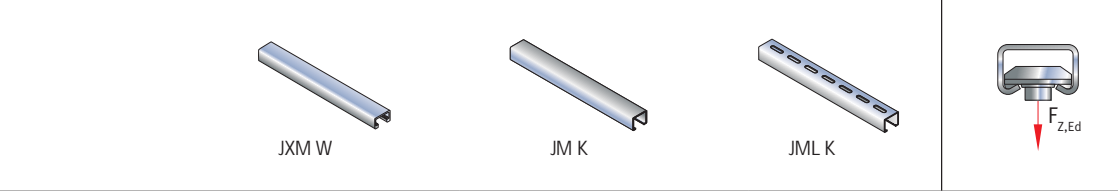
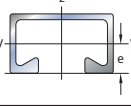
									
	Weight <sup>1)</sup>	Cross Section	Centre of Gravity	Moments of Inertia		Moments of Resistance			Max. Point Load Design Capacity <sup>2) 4)</sup>
	G [kg/m]	A [cm <sup>2</sup> ]	e [cm]	I <sub>y</sub> [cm <sup>4</sup> ]	I <sub>z</sub> [cm <sup>4</sup> ]	W <sub>y</sub> [cm <sup>3</sup> ]	W <sub>z</sub> [cm <sup>3</sup> ]	W <sub>pl,y</sub> [cm <sup>3</sup> ]	F <sub>z,Ed</sub> [kN]
<b>Hot-Rolled Profiles</b>									
JM W 72/48	8.84	11.27	2.40	34.97	83.27	14.57	23.13	18.28	65.8
JM W 55/42	6.76	8.61	2.21	18.75	36.27	8.49	13.31	11.72	54.0
JM W 53/34	4.98	6.34	1.74	9.33	23.70	5.35	9.03	7.18	36.3
JM W 50/30	3.23	4.12	1.60	5.19	13.89	3.24	5.67	4.34	20.2
JM W 40/22	2.10	2.68	1.22	1.97	5.87	1.62	2.97	2.15	11.4
JXM W 64/44	7.19	9.16	2.29	24.12	54.20	10.52	16.94	13.80	53.3
JXM W 53/34	4.64	5.91	1.85	9.25	23.19	5.01	8.83	6.86	43.3
JXM W 41/27	3.35	4.27	1.52	3.84	9.43	2.52	4.71	3.69	25.0
JXM W 38/23	2.42	3.08	1.33	2.10	6.13	1.57	3.23	2.30	18.0
JXM W 29/20	1.55	1.97	1.12	1.01	2.39	0.90	1.65	1.29	10.9
<b>Cold-Formed Profiles</b>									
JM K 72/48	8.11	10.33	2.87	29.36	75.44	10.23	20.96	15.67	55.6
JM K 53/34	4.49	5.72	2.00	8.11	22.40	4.05	8.38	6.16	35.0
JM K 50/40	3.41	4.34	2.23	9.37	16.46	4.20	6.59	5.81	16.8
JM K 50/30	3.01	3.84	1.77	4.33	13.54	2.45	5.42	3.69	16.8
JM K 48/26	2.25	2.87	1.50	2.65	9.23	1.76	3.85	2.52	11.2
JM K 41/41	2.60	3.32	2.30	7.03	9.02	3.05	4.40	4.37	11.2
JZM K 41/22	1.87	2.39	1.34	1.51	5.72	1.12	2.79	1.72	7.0
JM K 40/25	2.09	2.66	1.48	2.06	6.09	1.39	3.05	2.11	11.2
JM K 40/22	1.53	1.95	1.26	1.29	4.34	1.02	2.17	1.46	7.0
JM K 38/17	1.81	2.30	1.05	0.86	4.29	0.82	2.26	1.24	9.8
JM K 36/36	2.22	2.83	2.07	4.61	6.09	2.23	3.34	3.24	4.9
JM K 36/20	1.46	1.85	1.19	0.98	3.51	0.82	1.92	1.20	4.9
JM K 28/28	1.39	1.77	1.58	1.77	2.20	1.12	1.57	1.59	4.9
JM K 28/15	1.11	1.42	0.89	0.41	1.47	0.46	1.05	0.68	4.9
JM K 28/12	0.89	1.13	0.71	0.21	1.12	0.29	0.80	0.43	4.9
JM K 21/12	0.58	0.74	0.72	0.13	0.46	0.18	0.44	0.28	3.5
<b>Slotted-Back Profiles</b>									
JML K 50/40	3.15	4.01	2.10	8.44	16.41	4.02	6.56	5.29	16.8
JML K 41/41	2.39	3.04	2.15	6.19	9.00	2.87	4.39	3.91	11.2
JZML K 41/22	1.66	2.11	1.24	1.31	5.71	1.06	2.78	1.53	7.0
JML K 40/25	1.85	2.36	1.37	1.79	6.08	1.31	3.04	1.87	11.2
JML K 36/36	2.00	2.55	1.92	4.01	6.06	2.09	3.32	2.86	4.9
JML K 28/28	1.22	1.55	1.42	1.45	2.18	1.03	1.56	1.34	4.9
JML K 28/15	0.95	1.21	0.80	0.34	1.45	0.43	1.04	0.59	4.9

<sup>1)</sup> All weights per unit metre for mill finish steel. For galvanised profiles: weight per metre × 1.10 applies. For A4 profiles: weight per metre × 1.02 applies.

<sup>2)</sup> The factored resistance of the T-bolt (see pages 52, 53, and 55) as well as the factored resistance of the channel profile need to be considered. The lower value is applicable in each case.

## Bending Design Load Capacity <sup>2) 3) 4)</sup> for Support Width L

Permissible  
 $F = \frac{F_{Rd}}{1.4}$

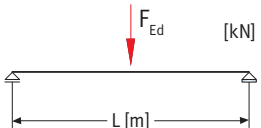
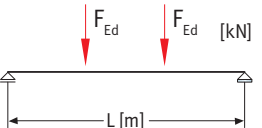
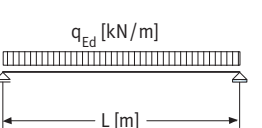
									
	L = 0.5 m	L = 1.0 m	L = 1.5 m	L = 0.5 m	L = 1.0 m	L = 1.5 m	L = 0.5 m	L = 1.0 m	L = 1.5 m
	$F_{Rd}$ [kN]			$F_{Rd}$ [kN]			$q_{Rd}$ [kN]		
<b>Hot-Rolled Profiles</b>									
JM W 72/48	34.4	17.2	11.5	25.8	12.9	8.6	137.5	34.4	15.3
JM W 55/42	25.8	12.9	7.8	19.3	9.7	4.6	103.1	25.8	8.4
JM W 53/34	13.5	6.7	3.9	10.1	5.1	2.3	54.0	13.5	4.2
JM W 50/30	8.2	4.1	2.2	6.1	2.9	1.3	32.6	7.8	2.3
JM W 40/22	4.0	1.9	0.8	3.0	1.1	0.5	16.2	3.0	0.9
JXM W 64/44	35.1	17.6	10.1	26.3	13.2	5.9	140.5	35.1	10.8
JXM W 53/34	17.5	8.7	3.9	13.1	5.1	2.3	69.8	13.9	4.1
JXM W 41/27	9.4	3.6	1.6	7.0	2.1	0.9	37.6	5.8	1.7
JXM W 38/23	5.9	2.0	0.9	4.4	1.2	0.5	23.4	3.2	0.9
JXM W 29/20	3.3	1.0	0.4	2.2	0.6	0.2	12.2	1.5	0.5
<b>Cold-Formed Profiles</b>									
JM K 72/48	31.3	15.7	10.4	23.5	11.8	7.2	125.3	31.3	13.1
JM K 53/34	11.7	5.8	3.4	8.7	4.4	2.0	46.6	11.7	3.6
JM K 50/40	9.9	5.0	3.4	7.4	3.8	2.3	39.8	9.9	4.2
JM K 50/30	7.0	3.5	1.8	5.2	2.4	1.1	27.9	6.5	1.9
JM K 48/26	4.3	2.2	1.1	3.2	1.5	0.7	17.2	4.0	1.2
JM K 41/41	7.5	3.8	2.5	5.6	2.8	1.7	29.8	7.5	3.1
JZM K 41/22	2.9	1.4	0.6	2.2	0.8	0.4	11.8	2.3	0.7
JM K 40/25	4.0	1.9	0.9	3.0	1.1	0.5	16.0	3.1	0.9
JM K 40/22	2.5	1.3	0.6	1.9	0.7	–	9.9	2.0	0.6
JM K 38/17	2.3	0.8	–	1.8	0.5	–	9.3	1.3	0.4
JM K 36/36	5.6	2.8	1.8	4.2	2.1	1.1	22.1	5.6	2.1
JM K 36/20	2.1	0.9	0.4	1.5	0.6	–	8.2	1.5	0.4
JM K 28/28	2.7	1.4	0.7	2.1	1.0	0.4	10.9	2.7	0.8
JM K 28/15	1.2	0.4	–	0.9	–	–	4.7	0.6	–
JM K 28/12	0.7	–	–	0.5	–	–	2.5	–	–
JM K 21/12	0.5	–	–	–	–	–	1.6	–	–
<b>Slotted-Back Profiles</b>									
JML K 50/40	9.1	4.5	3.1	6.8	3.4	2.1	36.2	9.1	3.8
JML K 41/41	6.7	3.4	2.2	5.0	2.5	1.5	26.7	6.7	2.8
JZML K 41/22	2.7	1.3	0.6	2.0	0.7	–	10.5	2.0	0.6
JML K 40/25	3.5	1.7	0.7	2.7	1.0	0.4	14.2	2.7	0.8
JML K 36/36	4.9	2.4	1.7	3.7	1.8	1.0	19.6	4.9	1.8
JML K 28/28	2.3	1.1	0.6	1.7	0.8	0.4	9.2	2.2	0.7
JML K 28/15	1.0	–	–	0.8	–	–	4.0	0.5	–

<sup>3)</sup> All design load capacities have been calculated elastically and plastically in accordance with EN 1993-1. Deflection limit  $l/150$  at working/ permissible load level. With detailed knowledge of the conditions, the structural engineer must prove partial safety factors. In practice, we recommend an estimate at approx. 80% of the above values.

<sup>4)</sup> For mounting channels in stainless steel, separate proof of bending must be demonstrated, taking account of the applicable E-module.

# JORDAHL® T-Bolts



All JORDAHL® T-bolts are perfectly adapted to the channel range and guarantee that attached components are securely fastened. There are suitable T-bolts with nuts for each channel type to deliver a positive connection.

## JORDAHL® Hook-Head T-Bolts

Hook-head T-bolts in smooth hot-rolled and cold-formed channels are used for positive connections. They can be used, for example, with JORDAHL® anchor channels JTA W to transfer central and shear tension loads reliably. With European Technical Approval **ETA-09/0338**.



## JORDAHL® Hammer-Head T-Bolts

Hammer-head T-bolts are perfectly matched with smooth, cold-formed JORDAHL® channels. Their smooth bolt heads create a positive connection, e.g., with JORDAHL® anchor channels JTA K 38/17. With European Technical Approval **ETA-09/0338**.



## JORDAHL® Toothed T-Bolts

The bolt teeth fit perfectly into toothed JORDAHL® channels. In combination with toothed T-bolts, the toothed JORDAHL® anchor channels JXA W can support loads in all directions. With German Technical Approval **Z-21.4-1690**.



## JORDAHL® Double-Notch Toothed T-Bolts

JORDAHL® double-notch toothed T-bolts are used with hot-rolled untoothed JORDAHL® channels. When the T-bolts are tightened, their teeth bite into the channel lips to create a positive, non-slip connection to resist longitudinal loads. It is therefore possible to transmit force with plain hot-rolled JORDAHL® channels in all directions.





## Determining the T-Bolt Length

T-bolt	Total m + s + u [mm]
M 6	8.8
M 8	11.3
M 10	13.9
M 12	17.3
M 16	21.8
M 20	27.0
M 24	32.5
M 27	35.8
M 30	38.6

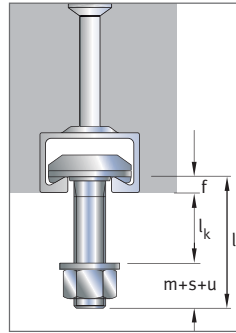

- l = T-bolt length
- l<sub>k</sub> = Clamping length  
(thickness of the attached part)
- f = Profile lip
- m = Nut height  
ISO 4032
- s = Washer thickness  
ISO 7093-1
- u = T-bolt projection  
ISO 4753

$$\text{min. } l \text{ [mm]} = l_k + f + (m+s+u)$$

### Example

JORDAHL® anchor channels JTA K 53/34,  
f = 8 mm,  
existing clamping length l<sub>k</sub> = 65 mm  
JORDAHL® T-bolt JB M16, 4.6 ZP

$$\text{min } l = 65 + 8 + 21.8 = 94.8 \text{ mm} \rightarrow 100 \text{ mm}$$

selected: JB M 16 × 100, 4.6 ZP

The T-bolts are supplied with nuts.  
Washers must be ordered separately (see page 60).

### Profile Lip Thickness f [mm]

Profile	f
W 72/48	15.5
W 55/42	12.9
W 53/34	11.5
W 50+	8.0
W 50/30	8.0
W 40+	6.0
W 40/22	6.0

Profile	f
K 72/48	10.0
K 53/34	8.0
K 50/30	6.5
K 40/25	5.0
K 38/17	3.0
K 28/15	2.3
K 21/12	1.6

Profile	f
XW 64/44	10.0
XW 53/34	7.5
XW 41/27	7.0
XW 38/23	5.5
XW 29/20	5.0
ZK 41/22	7.5

Profile	f
K 50/40	8.0
K 48/26	6.0
K 40/22	6.0
K 36/36	2.5
K 36/20	2.3
K 28/28	2.0
K 28/12	2.0

## Position Identification

Hook-head and hammer-head bolts are identified by **one pressed line (A)** on the end of the shank.

Toothed bolts and double-notched toothed bolts are identified by **two pressed lines (B)** on the end of the shank.

Following installation, the pressed line(s) must be at a right angle with the longitudinal direction of the channel!



## Hook-Head and Hammer-Head T-Bolts

## European Technical Approval ETA-09/0338

## Range of Hook-Head T-Bolts

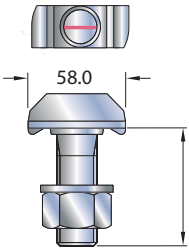
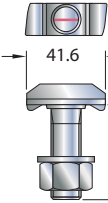
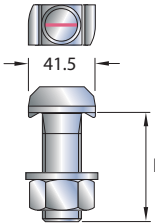
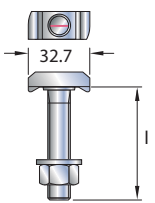
W 72/48, K 72/48				W 55/42, W 53/34, W 50+, W 50/30, K 53/34, K 50/30, K 50/40, K 48/26 <sup>3)</sup>						W 55/42		W 40+, W 40/22, K 40/22, K 40/25		
Type JA				Type JB			Type JE <sup>2)</sup>			Type JC				
														
Length l [mm]	M 20	M 24	M 27 M 30	Length l [mm]	M 10	M 12	M 16	Length l [mm]	M 20	M 24 <sup>2)</sup>	Length l [mm]	M 10	M 12	M 16
50	4.6 HDG 8.8 HDG	4.6 HDG A4-50		30	4.6 ZP A4-50	4.6 HDG 4.6 ZP A4-50	4.6 ZP A4-50	35	4.6 ZP 8.8 ZP A4-50		30	4.6 ZP A4-50	4.6 ZP A4-50	4.6 ZP A4-50
60	8.8 HDG			40	4.6 ZP	4.6 HDG 8.8 HDG 4.6 ZP A4-50 F4-70	4.6 HDG 8.8 HDG 4.6 ZP A4-50	45	4.6 HDG 4.6 ZP 8.8 ZP A4-50		40	4.6 HDG 4.6 ZP A4-50	4.6 HDG 8.8 HDG 4.6 ZP A4-50 F4-70	4.6 HDG 8.8 HDG 4.6 ZP 8.8 ZP A4-50 F4-70
75	4.6 HDG 8.8 HDG	4.6 HDG 8.8 HDG	4.6 HDG	50	4.6 ZP	4.6 HDG 8.8 HDG 4.6 ZP A4-50 F4-70	4.6 HDG 8.8 HDG 4.6 ZP 8.8 ZP A4-50 F4-70	55	4.6 HDG 8.8 HDG 4.6 ZP A4-50 F4-70		50	4.6 ZP A4-50	4.6 HDG 8.8 HDG 4.6 ZP 8.8 ZP A4-50 F4-70	4.6 HDG 8.8 HDG 4.6 ZP 8.8 ZP A4-50 F4-70
100	4.6 HDG 8.8 HDG 4.6 ZP	4.6 HDG 8.8 HDG A4-50	4.6 HDG	60	4.6 HDG 8.8 HDG 4.6 ZP	4.6 HDG 8.8 HDG 4.6 ZP A4-50 F4-70	A4-50	60		4.6 ZP	60	4.6 HDG 4.6 ZP A4-50	4.6 HDG 8.8 HDG 4.6 ZP 8.8 ZP A4-50	4.6 HDG 8.8 HDG 4.6 ZP 8.8 ZP A4-50 F4-70
125	8.8 HDG			65	4.6 HDG 8.8 HDG 4.6 ZP 8.8 ZP			65	A4-50		80	4.6 HDG 4.6 ZP	4.6 HDG 8.8 HDG 4.6 ZP 8.8 ZP A4-50	4.6 HDG 8.8 HDG 4.6 ZP 8.8 ZP A4-50 F4-70
150	4.6 HDG 8.8 HDG 4.6 ZP	8.8 HDG 4.6 ZP A4-50 F4-70	4.6 ZP <sup>1)</sup>	80	4.6 ZP	4.6 HDG 8.8 HDG 4.6 ZP A4-50	4.6 HDG 8.8 HDG 4.6 ZP 8.8 ZP A4-50 F4-70	75	4.6 HDG 8.8 HDG 4.6 ZP A4-50 F4-70	4.6 HDG 4.6 ZP	100	4.6 HDG 4.6 ZP	4.6 HDG 8.8 HDG 4.6 ZP 8.8 ZP A4-50 F4-70	4.6 HDG 8.8 HDG 4.6 ZP 8.8 ZP A4-50
200	4.6 HDG	4.6 HDG 8.8 HDG	4.6 HDG <sup>1)</sup>	100	4.6 ZP	4.6 HDG 8.8 HDG 4.6 ZP A4-50 F4-70	4.6 HDG 8.8 HDG 4.6 ZP 8.8 ZP A4-50	80	F4-70		125		8.8 HDG 4.6 ZP 8.8 ZP	8.8 HDG 4.6 ZP 8.8 ZP
				125		4.6 HDG 8.8 HDG 4.6 ZP 8.8 ZP A4-50	8.8 HDG 4.6 ZP 8.8 ZP A4-50	100	4.6 HDG 8.8 HDG 4.6 ZP 8.8 ZP A4-50 F4-70	4.6 HDG	150		8.8 HDG 4.6 ZP 8.8 ZP A4-50	8.8 HDG 4.6 ZP 8.8 ZP A4-50
				150		4.6 ZP	4.6 HDG 4.6 ZP A4-50	125	4.6 HDG 8.8 HDG 4.6 ZP 8.8 ZP A4-50		200		8.8 HDG 4.6 ZP 8.8 ZP	8.8 HDG 4.6 ZP A4-50
				200		8.8 HDG 4.6 ZP	4.6 ZP A4-50	150	4.6 HDG 8.8 HDG 4.6 ZP 8.8 ZP A4-50 F4-70	8.8 ZP	250			4.6 ZP
				300		4.6 ZP	4.6 ZP	200	4.6 HDG 4.6 ZP		300			4.6 ZP
				300				300	4.6 ZP					

<sup>1)</sup> Not available as JA M 27.

<sup>2)</sup> JB M 24 is equivalent to JE M 24.

<sup>3)</sup> K 48/26 – M 20 8.8 cannot be used.

## Range of Hammer-Head T-Bolts

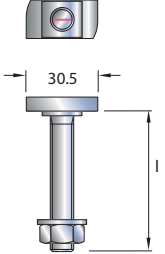
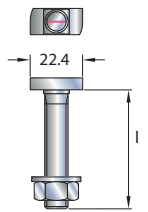
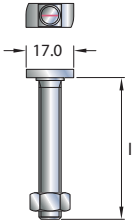
K 38/17, K 36/36, K 36/20				K 28/28, K 28/15, K 28/12				K 28/28, K 28/15	K 21/12		
Type JH				Type JD					Type JG		
											
Length l [mm]	M 10	M 12	M 16	Length l [mm]	M 6	M 8	M 10	M 12	Length l [mm]	M 6	M 8
20	4.6 HDG 4.6 ZP	4.6 ZP	4.6 ZP	15	4.6 ZP	4.6 ZP	4.6 ZP	4.6 ZP	15	4.6 ZP	4.6 ZP
25		4.6 ZP A4-50 A4-70	A4-50	20	4.6 ZP	4.6 ZP	4.6 ZP		20	4.6 ZP	4.6 ZP
30	4.6 HDG 4.6 ZP A4-50 A4-70	4.6 HDG 8.8 HDG 4.6 ZP 8.8 ZP A4-50 A4-70	8.8 HDG 4.6 ZP 8.8 ZP A4-50	25	4.6 ZP	4.6 ZP	4.6 ZP A4-50 A4-70		25		4.6 ZP
40	4.6 ZP A4-50 A4-70	4.6 HDG 4.6 ZP A4-50 A4-70	4.6 HDG 4.6 ZP A4-50	30	4.6 ZP	4.6 ZP A4-50 A4-70	4.6 HDG 4.6 ZP A4-50 A4-70	4.6 ZP	30	4.6 ZP	4.6 ZP A4-50
50	4.6 HDG 4.6 ZP A4-50 A4-70	4.6 HDG 4.6 ZP A4-50 A4-70	4.6 HDG 4.6 ZP A4-50	40	4.6 ZP	4.6 ZP	4.6 HDG 4.6 ZP A4-50 A4-70	4.6 ZP	40	4.6 ZP	4.6 ZP A4-50
60	4.6 HDG 4.6 ZP A4-50 A4-70	4.6 HDG 4.6 ZP A4-50 A4-70	4.6 HDG 8.8 HDG 4.6 ZP A4-50	50	4.6 ZP	4.6 ZP	4.6 ZP A4-50 A4-70	4.6 HDG 4.6 ZP	50	4.6 ZP	4.6 ZP A4-50
80	4.6 HDG 4.6 ZP	4.6 HDG 4.6 ZP A4-50	4.6 HDG 4.6 ZP A4-50	60	4.6 ZP	4.6 ZP	4.6 ZP A4-50 A4-70	4.6 HDG	60	4.6 ZP	4.6 ZP
100	4.6 ZP	4.6 HDG 8.8 HDG 4.6 ZP A4-50 A4-70	4.6 HDG 4.6 ZP A4-50 A4-70	80		4.6 HDG 4.6 ZP	4.6 ZP A4-50	4.6 HDG 4.6 ZP	80		4.6 ZP
125	4.6 ZP	4.6 ZP 8.8 ZP	4.6 ZP	100		4.6 HDG 4.6 ZP	4.6 HDG 4.6 ZP A4-50 A4-70		100		4.6 ZP
150	4.6 ZP	4.6 ZP 8.8 ZP A4-50	4.6 ZP 8.8 ZP A4-50	125		4.6 ZP	4.6 ZP A4-50				
200		4.6 ZP 8.8 ZP A4-50	A4-50	150		4.6 ZP	4.6 ZP A4-50				
				200			4.6 ZP				

### T-Bolt Material and Design

- Hot-dip galvanised steel (HDG), strength grade 4.6
- Hot-dip galvanised steel (HDG), strength grade 8.8
- Zinc electroplated steel (ZP), strength grade 4.6
- Zinc electroplated steel (ZP), strength grade 8.8
- Stainless steel A4-50
- Stainless steel A4-70
- Stainless steel F4-70 (≙ FA-70)

### Ordering Example for JORDAHL® T-Bolts

Type	Thread Ø		Length [mm]	Strength Grade	Material
JB	M 16	×	100	4.6	ZP

## Hook-Head and Hammer-Head T-Bolts

### T-Bolts Made of Steel

#### Design resistances

T-Bolts Ø		M 6	M 8	M 10	M 12	M 16	M 20	M 24	M 27	M 30	
Channel Profile	JTA-CE	K 28/15	Hammer-head T-bolts JD			–	–	–	–	–	
		K 38/17	–	–	Hammer-head T-bolts JH		–	–	–	–	
		W 40+ W 40/22 K 40/25	–	–	Hook-head T-bolts JC		–	–	–	–	
		W 50+ W 50/30 K 50/30	–	–	Hook-head T-bolts JB			–	–	–	
		W 53/34 K 53/34	–	–	Hook-head T-bolts JB			–	–	–	
		W 55/42	–	–	Hook-head T-bolts JB/JE				–	–	
		W 72/48 K 72/48	–	–	–	–	–	Hook-head T-bolts JA			
Design Resistance Capacity of T-Bolt	4.6	Tensile force $N_{Rd}$ [kN]	4.0	7.3	11.6	16.9	31.4	49.0	70.6	91.8	112.2
		Shear force $V_{Rd}$ [kN]	2.9	5.3	8.4	12.1	22.6	35.2	50.7	66.0	80.6
	8.8	Tensile force $N_{Rd}$ [kN]	–	19.5	30.9	44.9	83.7	130.7	188.3	–	–
		Shear force $V_{Rd}$ [kN]	–	11.7	18.6	27.0	50.2	78.4	113.0	–	–

JORDAHL® T-bolts are supplied zinc electroplated (ZP) or hot-dip galvanised (HDG).

#### Design bending moments

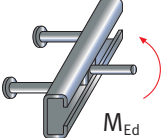
T-Bolts Ø		M 6	M 8	M 10	M 12	M 16	M 20	M 24	M 27	M 30
Max. Through-Hole in Attached Component [mm]		7	9	12	14	18	22	26	30	33
Design Bending Moment $M_{Rd,s}$ [Nm] 	4.6	3.8	9.0	17.9	31.4	79.8	155.4	268.9	398.7	538.7
	8.8	9.8	24.0	47.8	83.8	213.1	415.4	718.4	1065.2	1439.4



#### Stand-off installation

In stand-off installation, a connection is loaded with a bending moment, as well as tension and shear forces. The above design bending moments must be noted. The correct washer can be found on page 60.



#### JORDAHL Note

The load-bearing capacity of the bolt may be limited by the load-bearing capacity of the channel. The lower value applies. The specified values are design resistances. To obtain the permissible values, divide by the partial factor 1.4 for the loads.

## T-Bolts Made of Stainless Steel

### Design resistances

T-Bolts Ø		M 8	M 10	M 12	M 16	M 20	M 24	
Channel Profile	JTA-CE	K 28/15	Hammer-head T-bolts JD		–	–	–	–
		K 38/17	–	Hammer-head T-bolts JH			–	–
		W 40/22 K 40/25	–	Hook-head T-bolts JC			–	–
		W 50/30 K 50/30	–	Hook-head T-bolts JB				–
		W 53/34 K 53/34	–	Hook-head T-bolts JB				–
		W 72/48 K 72/48	–	–	–	–	–	Hook-head T-bolts JA
Design Resistance Capacity of T-Bolt	A4-50	Tensile force $N_{Rd}$ [kN]	–	10.1	14.8	27.4	42.8	61.7
		Shear force $V_{Rd}$ [kN]	–	7.3	10.6	19.8	30.9	44.5
	F4-70	Tensile force $N_{Rd}$ [kN]	13.7	21.7	31.6	58.8	91.7	–
		Shear force $V_{Rd}$ [kN]	9.9	15.6	22.7	42.2	66.0	–

JORDAHL® stainless steel bolts are typically made from stainless steel from corrosion categories C4 (A4, L4) and C5 (F4, HC).

### Design bending moments

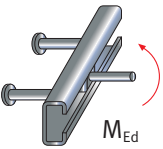
T-Bolts Ø	M 8	M 10	M 12	M 16	M 20	M 24	M 27	M 30
Through-Hole in Attached Component [mm]	9	12	14	18	22	26	30	33
Design Bending Moment $M_{Rd,s}$ [Nm] 	A4-50	7.9	15.7	27.5	70.0	136.3	235.8	–
	A4-70 F4-70	16.8	33.5	58.8	149.4	291.3	503.7	–



JORDAHL® hook-head T-bolts.



#### JORDAHL Note

JORDAHL® T-bolts are supplied zinc electroplated (ZP), hot-dip galvanized (HDG), or in stainless steel (A4): select bolts according to required level of corrosion protection.

## Toothed T-Bolts and Double-Notch Toothed T-Bolts

### Range of Toothed T-Bolts

JXA W 64/44 <sup>1)</sup>			JXA W 53/34 <sup>1)</sup>			JXA W 38/23 <sup>1)</sup>			JXA W 29/20 <sup>1)</sup>			JZA K 41/22 <sup>2)</sup>		
Type JXE			Type JXB			Type JXH			Type JXD			Type JZS		
Length l [mm]	M 20	M 24	Length l [mm]	M 16	M 20	Length l [mm]	M 12	M 16	Length l [mm]	M 10	M 12	Length l [mm]	M 12	M 16
50	F4-70	F4-70	60	8.8 HDG F4-70	8.8 HDG	30	8.8 HDG	8.8 HDG	30		8.8 HDG	35	8.8 HDG A4-50	A4-50
60	8.8 HDG		65		8.8 HDG	40	8.8 HDG F4-70	8.8 HDG	40	8.8 HDG	8.8 HDG F4-70	50	8.8 HDG A4-50	8.8 HDG A4-50
75		8.8 HDG	80	8.8 HDG F4-70	8.8 HDG F4-70	50	8.8 HDG	8.8 HDG	50		8.8 HDG	80	8.8 HDG A4-50	8.8 HDG A4-50
100	8.8 HDG F4-70	8.8 HDG F4-70	100	8.8 HDG F4-70	8.8 HDG F4-70	60	8.8 HDG F4-70	8.8 HDG F4-70	60		8.8 HDG F4-70	100		8.8 HDG A4-50
150	8.8 HDG	8.8 HDG	150		8.8 HDG F4-70	80	8.8 HDG F4-70	8.8 HDG	80		8.8 HDG F4-70			
						100	8.8 HDG	8.8 HDG	100		8.8 HDG			
						125		8.8 HDG	125		8.8 HDG			
						150		8.8 HDG	150		8.8 HDG			
						200		8.8 HDG						

<sup>1)</sup> German Technical Approval abZ Z-21.4-1690.

<sup>2)</sup> German Technical Approval abZ Z-21.4-741.

### Range of Double-Notch Toothed T-Bolts

JTA W 50/30, JTA W50+, JTA W 53/34, JTA W 55/42 <sup>3)</sup>			W40+, JTA W 40/22		
Type JKB			Type JKC		
Length l [mm]	M 16	M 20	Length l [mm]	M 16	
40	8.8 HDG	8.8 HDG	40	8.8 HDG	
60	8.8 HDG	8.8 HDG	60	8.8 HDG	
80	8.8 HDG	8.8 HDG	80	8.8 HDG	
100	8.8 HDG				



JORDAHL® double-notch toothed T-bolt JKB.



The notched teeth of the T-bolt are pressed into the channel lips.

<sup>3)</sup> Only M 20.

## Toothed T-Bolts

### Design resistances

T-Bolts Ø		M 10	M 12	M 16	M 20	M 24	
Channels	JXA, JXA-PC	W 29/20	Toothed T-bolt JXD		–	–	–
		W 38/23	–	Toothed T-bolt JXH		–	–
		W 53/34	–	–	Toothed T-bolt JXB		–
		W 64/44	–	–	–	Toothed T-bolt JXE	
	JZA	K 41/22	–	Toothed T-bolt JZS		–	–
Design Resistance Capacity of T-Bolt	8.8	F <sub>Rd</sub> [kN]	18.6	27.2	50.5	79.0	113.7
	A4-50	F <sub>Rd</sub> [kN]	–	13.0	24.2	–	–
	A4-70	F <sub>Rd</sub> [kN]	12.2	17.6	33.0	51.5	95.1

$$\sqrt{N_{Ed}^2 + V_{Ed}^2 + X_{Ed}^2} \leq F_{Rd}$$



JORDAHL® toothed T-bolt JXB.

### Design bending moments

T-Bolts Ø		M 10	M 12	M 16	M 20	M 24
Through-Hole in Attached Component [mm]		12	14	18	22	26
Design Bending Moment M <sub>Rd</sub> [Nm] 	8.8	34.9	61.2	155.4	303.0	718.3
	A4-50	–	21.4	54.3	–	–
	A4-70	26.2	45.9	116.6	227.2	503.2

## Double-Notch Toothed T-Bolts

Permissible  
 $F = \frac{F_{Rd}}{1.4}$

### Design resistances

JORDAHL® double-notched toothed T-bolts avoid slippage by using high torques to bite into the channel lips. This T-bolt can transfer longitudinal loads X<sub>Ed</sub> in the longitudinal direction of the channel of up to 10.5 kN with a safety factor of 3. It is only intended for hot-dip galvanised hot-rolled profiles JTA W and JM W. Corrosion protection by galvanisation is fully maintained after installation.

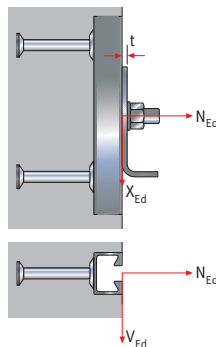

Type	For Profiles JTA:	Recommended Tightening Torque M <sub>A</sub>	Min. Attached Component Thickness t	Longitudinal Load <sup>1)</sup> X <sub>Rd</sub>
<b>8.8 HDG</b>	<b>HDG, black</b>	[Nm]	[mm]	[kN]
JKB M 16	W 50/30	180	6	7.0
JKB M 20	W 53/34	360	8	10.5
JKB M 20	W 55/42	360	8	10.5
JKC M 16	W 40/22	180	6	7.0

<sup>1)</sup> In the event of simultaneous stressing in several directions, the resultant load must not exceed the permissible loads for the anchor channels according to ETA-09/0338.

$$\sqrt{N_{Ed}^2 + V_{Ed}^2 + X_{Ed}^2} \leq F_{Rd}$$

# JORDAHL® T-Bolts

## Pre-Loaded Bolt Connections

### Prestressing forces of T-bolts

In applications involving suspended loads, stand-off installations, and situations where the channel is longitudinally loaded, it is important to prestress bolted connections by applying tightening torques. This is in order to prevent undesired loosening or slippage of the bolted connections during service if the applied loads exceed the prestressing force. Higher-strength T-bolts (8.8) are not absolutely necessary for this purpose. Strength grade 4.6 and A4-50 bolts are also adequate if the following points are taken into consideration:

- In the short term, a force arising from prestressing with tightening torque is normally higher than the external load.
- Over time the applied prestressing force is reduced by approximately 30 % due to relaxation.
- T-bolts made of stainless steel exhibit higher friction than zinc electroplated or hot-dip galvanised bolts. Therefore, stainless steel bolts produce lower prestressing forces.
- JORDAHL® T-bolts are supplied ready for installation. They should not be additionally oiled or treated with lubricants before the tightening torque is applied.

- Strength grade 8.8 T-bolts may be fully prestressed only when hot-rolled channels are used and there is contact between the face of the channel and the connected component.
- If the channel is set back behind the concrete surface, then the connection must be shimmed by means of a suitable washer (see pages 29 and 60). If this requirement is not met and the attached part is prestressed against the concrete surface, it leads to residual stresses in the component. This can cause cracks or splitting of the concrete component and damage the anchor channel.

### Suspended and stand-off installation

For these applications, cold-formed and hot-rolled profiles can be used. In order to prestress a bolted joint with zinc electroplated bolts or stainless steel bolts, we recommend using the appropriate tightening torques. In the case of cold-formed profiles, the tightening torques of strength grade 4.6 T-bolts should be used. Fully tightening grade 8.8 T-bolts is only recommended for connections to hot-rolled channels.

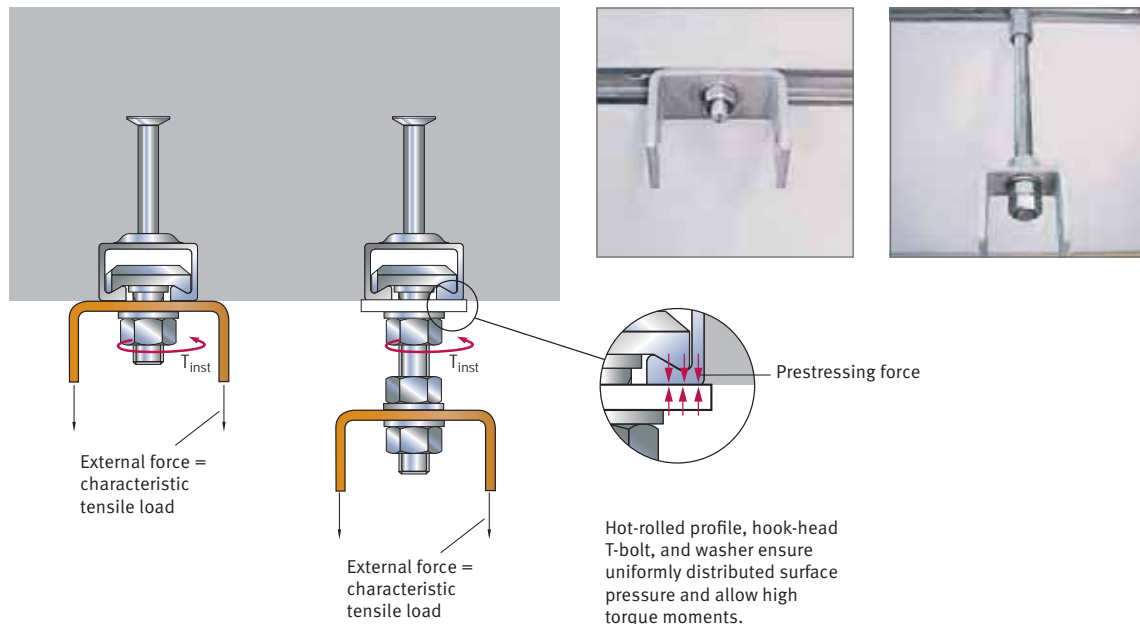



## Relationship Between Prestressing Force and Tightening Torque

The relationship between prestressing force and tightening torque can be seen from the graphs below. The prestressing forces vary greatly with the friction in the thread between the nut and the T-bolt. Low friction causes a higher pre-load, typical for hot-dip galvanised bolts with lubricated nuts (very low).

Friction is increased for zinc electroplated (medium) and stainless steel (high) nuts and T-bolts. The recommended tightening torque may be increased by 30 % without danger of reaching the yield strength of the T-bolts.

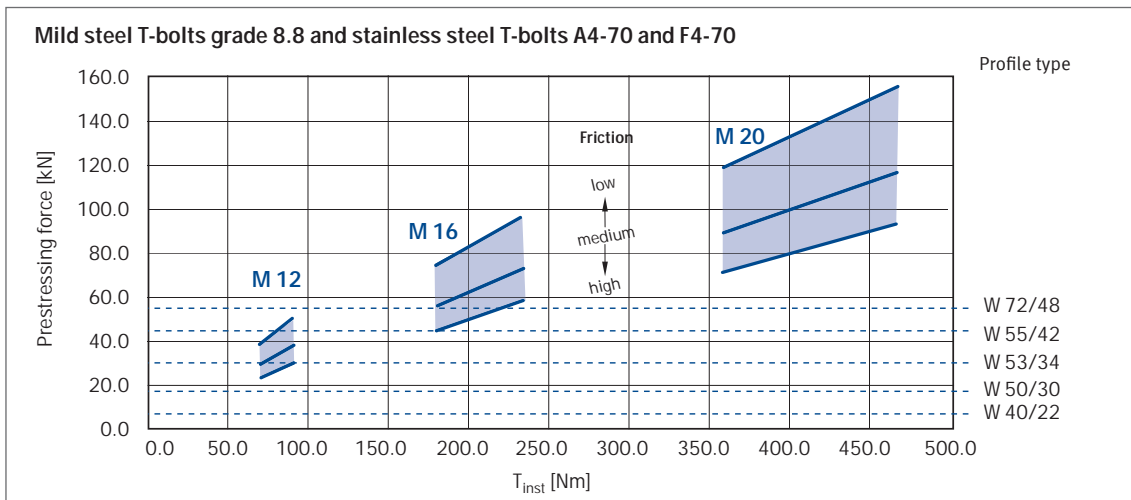
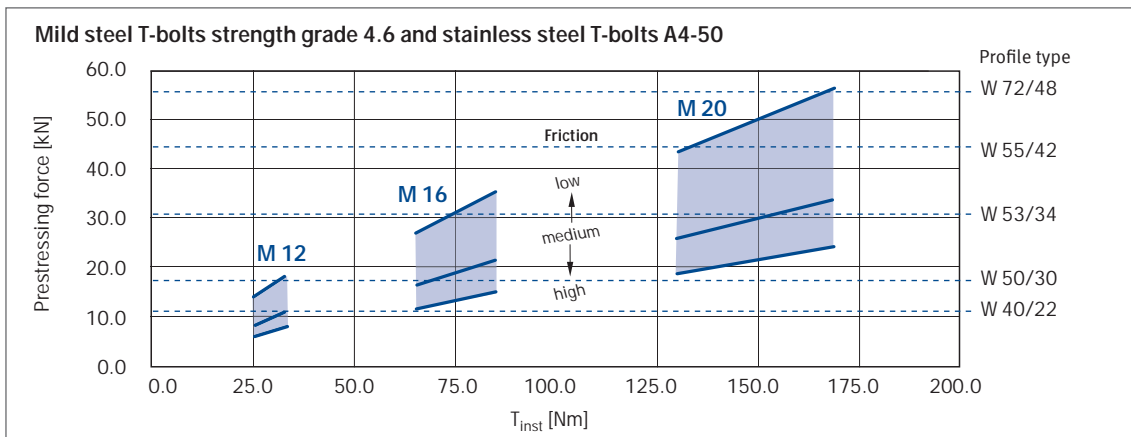

### JORDAHL Information

The tightening torques and notes on stand-off installation can be found on page 29 (installing anchor channels).

# JORDAHL® T-Bolts

## Loading Hook-Head T-Bolts in Longitudinal Direction

$$F_{Rd} = \frac{\text{allowable}}{F \times 1.4}$$

This application is documented by means of internal tests and is not part of the Technical Approval. The load that can be absorbed depends on the anchor channel material, the T-bolt type and T-bolt material used, and the tightening torque.

The safety factor against slippage is approximately  $\gamma = 5.0$  with the specified tightening torques. The specified loads in the channel longitudinal direction can be absorbed safely in conjunction with hot-rolled profiles and T-bolts of strength grade 8.8 and FA-70.

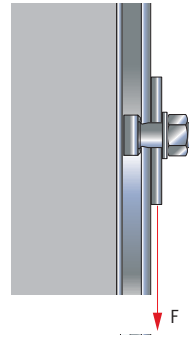

For applications with higher loads in the longitudinal direction of the channel, JORDAHL® toothed channels JXA and JZA with approval should be used.

### Recommended load-bearing capacity of hot-rolled anchor channels JTA W longitudinal to channel axis

Profile JTA	T-Bolts		Tightening Torques MA [Nm]	Recommended Load-Bearing Capacity in Longitudinal Direction max. F [kN]		Minimum Thickness of Attached Components [mm]
	Type	Ø		Profile Hot-Dip Galvanised Steel	Profile Stainless Steel Degreased	
				T-Bolts 8.8	T-Bolts FA-70	
W 72/48	JA	M 24	620	4.2	1.96	10
		M 20	360	2.9	1.36	
W 55/42	JB <sup>1)</sup>	M 24	620	4.2	1.96	10
		M 20	360	2.9	1.36	
		M 16	180	1.9	0.85	
W 53/34	JB	M 20	360	2.9	1.36	6
		M 16	180	1.9	0.85	
W 50+ W 50/30	JB	M 20	360	2.9	1.36	6
		M 16	180	1.9	0.85	
		M 12	70	0.9	0.44	
W 40+ W 40/22	JC	M 16	180	1.9	0.85	5
		M 12	70	0.9	0.44	

<sup>1)</sup>JB M 24 is equivalent to JE M 24.

# JORDAHL Accessories



JORDAHL®  
Hook-Head Sliding Nuts JGM

In the following pages, you will find a large number of products that can meet a huge variety of fastening requirements. Manufactured from high-quality material, they are perfect for use with JORDAHL® channels.



JORDAHL®  
Hook-Head Sliding Nuts JGM



JORDAHL®  
Hammer-Head Sliding Nuts JGM



**NEW!**

JORDAHL®  
Toothed Straps JVB-V



Clamping Plates



JORDAHL®  
Clamp Connections JSV



Eyelet Sockets/Sleeve Anchors



JORDAHL®  
Toothed Straps JVB-Z



**NEW!**

JORDAHL®  
Toothed Straps JVB-N

## T-Bolt Accessories

### Washers

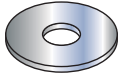
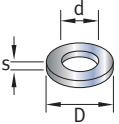
Washers	Size	d [mm]	D [mm]	s [mm]	Material
ISO 7093-1 (DIN 9021) 	M 6	6.4	18.0	1.6	HDG ZP A4
	M 8	8.4	24.0	2.0	
	M 10	10.5	30.0	2.5	
	M 12	13.0	37.0	3.0	
	M 16	17.0	50.0	3.0	
	M 20	22.0	60.0	4.0	
ISO 7089 -200HV (DIN 125 -140HV) 	M 6 <sup>1)</sup>	6.4	12.0	1.6	
	M 8 <sup>1)</sup>	8.4	16.0	1.6	
	M 10	10.5	20.0	2.0	
	M 12	13.0	24.0	2.5	
	M 16	17.0	30.0	3.0	
	M 20	21.0	37.0	3.0	
	M 24	25.0	44.0	4.0	
	M 27	28.0	50.0	4.0	
	M 30	31.0	56.0	4.0	

<sup>1)</sup> 140 HV.

### JORDAHL® Square Shim JVL for Steel-Steel Contact

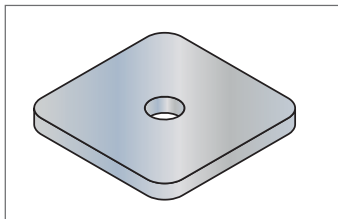

Square shim JVL

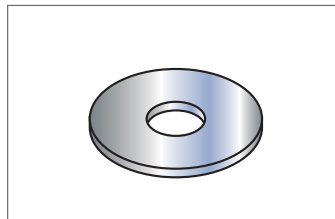

Washer ISO 7093-1

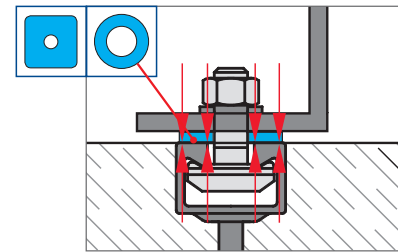

JORDAHL® Profile	T-Bolt Type	M 8	M 10	M 12	M 16	M 20	M 24	M 27	M 30
JTA K 28/15	JD	ISO 7093-1	ISO 7093-1	ISO 7089	–	–	–	–	–
JXA W 29/20	JXD	–		ISO 7093-1	ISO 7093-1	–	–	–	–
JTA K 38/17	JH	–	JVL 3805-10	ISO 7093-1 or JVL 3805-12	ISO 7093-1 or JVL 3805-16	–	–	–	–
JTA W 40/22 <sup>3)</sup>	JC	–		–	–	–	–	–	–
JTA K 40/25	JC	–		–	–	–	–	–	–
JZA K 41/22	JZS	–	–	JVL 3805-12	JVL 3805-16	–	–	–	–
JXA W 38/23	JXH	–	–	–	–	–	–	–	–
JTA W 50/30 <sup>4)</sup>	JB	–	JVL 5006-10	JVL 5006-12	JVL 5006-16	JVL 5006-20	–	–	–
JTA K 50/30		–					–	–	–
JTA W 53/34		–					–	–	–
JTA K 53/34		–					–	–	–
JXA W 53/34	JXB	–	–	–	–	–	–	–	–
JTA W 55/42	JB <sup>2)</sup>	–	–	–	–	–	JVL 5006-24	–	–
JXA W 53/34	JXB	–	–	–	–	–	–	–	–
JTA W 72/48	JA	–	–	–	–	JVL 7008-20	JVL 7008-24	JVL 7008-27	JVL 7008-30
JTA K 72/48		–	–	–	–	–	–	–	–

<sup>2)</sup> JB M 24 is equivalent to JE M 24.

<sup>3)</sup> Same applies for profile JTA W40+.

<sup>4)</sup> Same applies for profile JTA W 50+.

### Ordering Example for JORDAHL® Square Shims

Type	Width	Thickness	Ø	Material
JVL	50	06	– 12	A4

## JORDAHL® Double-Toothed Shims

JORDAHL® double-toothed shims guarantee a slip-resistant bolted connection in slotted holes. Using two teeth on the underside of the shim to bite into the bracket material provides a mechanical resistance to slip of up to  $V_{Ed} = 7.5$  kN with a safety factor of 3. This is achieved while retaining the adjustment advantage of the slot to compensate for construction tolerances.

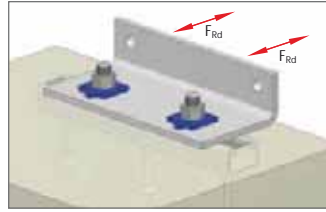

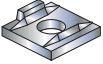
Double-Toothed Shim	Type and Design	Geometry l x w x h [mm]	For T-Bolt	$F_{Rd}$ [kN]	Tightening Torque [Nm]	Attached Component	
						Min. Thickness [mm]	Yield Point [N/mm <sup>2</sup> ]
	<b>JKZS 16 HDG</b>	40 × 40 × 6	M 16 8.8	7.5	200	8	≤ 240

## Spring Washers (DIN 127)

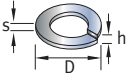
	Size	$h_{min}$ [mm]	$D_{max}$ [mm]	s [mm]	Material
	A 6	3.6	11.8	1.6	ZP A4
	A 8	4.6	14.8	2.0	
	A 10	5.0	18.1	2.2	
	A 12	5.8	21.1	2.5	
	A 16	7.8	27.4	3.5	
	A 20	8.8	33.6	4.0	
	A 24	11.0	40.0	5.0	
	A 30	13.6	48.2	6.0	

## Self-Locking Nuts with Serrated Bearing

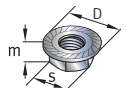
	Thread	D [mm]	m [mm]	s [mm]	t [mm]	Material
	M 12	26.0	12	18	2.3	ZP Strength grade 8
	M 16	34.5	16	24	2.1	

## Hexagon Nuts according to ISO 4032<sup>1)</sup>

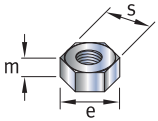
	Thread	e [mm]	s [mm]	m [mm]	Material
	M 6	11.05	10.0	5.2	A4 ZP Strength grade 8
	M 8	14.38	13.0	6.8	
	M 10	18.90	16.0	8.4	
	M 12	21.10	18.0	10.8	
	M 16	26.75	24.0	14.8	
	M 20	32.95	30.0	18.0	
	M 24	39.55	36.0	21.5	
	M 27	45.20	41.0	23.8	
	M 30	50.85	46.0	25.6	

<sup>1)</sup> We recommend self-locking nuts for cyclic loads.

## JORDAHL® Sliding Nuts

### Permissible

$$F = \frac{F_{Rd}}{1.4}$$

### Application



JORDAHL® sliding nuts (locking plates) can be used at any point on the channel. The nut is inserted through the channel opening and rotated 90° to lock in position. Sliding nuts are normally used for stand-off installation in combination with long bolts or threaded rods. Installation often cannot be checked because the nuts can be hidden by the attached component. For this reason, this product group is not recommended for safety-relevant installations, and they are not covered by building approval.



### Hook-head sliding nuts

Hook-head sliding nuts are forged with an accurate shape to ensure a secure locking fit in heavy and medium duty JORDAHL® channels. Before inserting into the channel, we recommend either pre-threading the nuts on the threaded rod by a couple of turns or pre-inserting a thin strip of foam inside the channel, to aid installation.

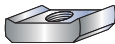
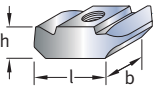
### Hammer-head sliding nuts

Hammer-head sliding nuts are used with light duty cold-formed channels for less important connections. They clamp without the locking fit provided by hook-head sliding nuts.

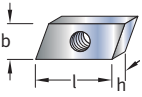
Hook-Head Sliding Nuts (forged)	Type	Geometry l × b × h	With Thread	F <sub>Rd</sub> [kN] <sup>1)</sup>	Material	Corresponding Profile
	JGM A	57 × 31 × 22	M 20	37.8	4.6 ZP	K 72/48 W 72/48
	JGM B	41 × 21 × 16	M 6	3.1	4.6 ZP A4-50	K 48/26 W 50+ W 50/30 K 50/30 K 50/40 W 53/34 K 53/34 W 55/42
			M 8	5.6		
			M 10	9.0		
			M 12	13.0		
	JGM C	32 × 17 × 11	M 16	16.8	4.6 ZP A4-50	W 40+ W 40/22 K 40/25 K 40/22
			M 6	3.1		
			M 8	5.6		
		32 × 23 × 13	M 10	9.0		
			M 12	11.2		
			M 16	11.2		

Hammer-Head Sliding Nuts JGM (flat steel)	Type	Geometry l × b × h	With Thread	F <sub>Rd</sub> [kN] <sup>1)</sup>	Material	Corresponding Profile
	JGM H	30 × 14 × 6	M 5	2.2	4.6 ZP A4-50	K 38/17 K 36/36 K 36/20
			M 6	3.1		
			M 8	5.6		
			M 10	9.0		
	JGM D	21 × 12 × 4	M 12	9.8	4.6 ZP A4-50	K 28/15 K 28/28 K 28/12
			M 4	1.4		
			M 5	2.2		
			M 6	3.1		
	JGM G	16 × 12 × 4	M 8	4.9	4.6 ZP A4-50	K 21/12
			M 10	4.9		
			M 4	1.4		
			M 5	2.2		
		16 × 12 × 6	M 6	3.1		
			M 8	3.5		

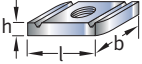
Channel Nuts	Type	Geometry l × b	With Thread	h	F <sub>Rd</sub> [kN] <sup>1)</sup>	Material	Corresponding Profile
	JAM 22	35 × 20	M 6	6.0	3.1	4.6 ZP	K 41/41
	JAM F 22 with spring		M 8	6.0	5.6		
			M 10	8.0	9.0		
			M 12	9.5	11.2		

<sup>1)</sup> The design load capacities of the sliding nut may be limited by the capacity of either its supporting anchor channel, or mounting channel. The lower value applies in each case.

<sup>2)</sup> 24.2 kN is only permitted in profiles W53/34 and W55/42.

## Threaded Rods DIN 976-1 (length L = 1000 mm)

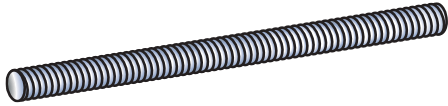

Thread	M 6	M 8	M 10	M 12	M 16	M 20
Design-Resistance Capacity $F_{Rd}$ [kN]	3.1	5.6	9.0	13.0	24.0	37.8
Material	4.6 ZP, A4-50					

## Flange Clamping Plates, Clamping Claw



JORDAHL® flange clamping plates are suitable for securing standard steel beams from the I and IPB series, as well as crane rails. **Material: HDG**

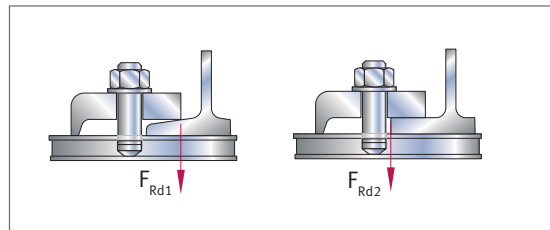

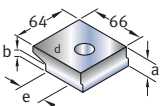
Clamping Plate KPA for Crane Rails <sup>1)</sup>	Type	Suitable for Crane Rail	a [mm]	b [mm]	For T-Bolts <sup>1)</sup>	d [mm]	e [mm]
	KPA 45	A 45 (KS 22)	22.0	8.5	M 20	× 22	18
	KPA 55	A 55 (KS 32)	22.5	9			
	KPA 65	A 65 (KS 43)	23.5	10			
	KPA 75	A 75 (KS 56)	24.5	11			

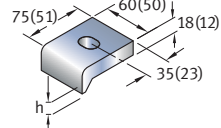
Clamping Plate KP (previously DIN 3568)	Type	h [mm]	For T-Bolts Ø	Suitable for I-Beams <sup>5)</sup>	IPB Beams (HEB) <sup>5)</sup>	$F_{Rd}$ [kN] according to DIN 3568
 LL 18 × 24 (14 × 20)	KP 50/7 <sup>4)</sup>	7	M 12 x 50	80 – 120	—	$F_{Rd} = 5.25$ kN
	KP 60/10	10		120 – 160	100	$F_{Rd1} = 9.8$ kN $F_{Rd2} = 15.8$ kN
	KP 60/11	11		180 – 200	120	
	KP 60/12 <sup>2)</sup>	12		220 – 240	140	
	KP 60/14 <sup>3)</sup>	14		260 – 280	160 – 180	
	KP 60/16	16		300 – 340	200 – 220	
	KP 60/18	18		360 – 380	240 – 260	
KP 60/20	20	400 – 450	280 – 300			

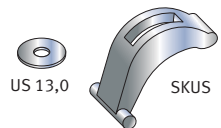
Universal Clamping Claw with Washer	Type	Clamping Height h [mm]	T-Bolt Dimension [mm]	$F_{Rd}$ [kN]
	SKU	5 – 40 (35) <sup>6)</sup>	M 12 × 100 (80) <sup>6)</sup> Strength grade 8.8 Washer 13.0 ISO 7093-1 (DIN 9021)	$F_{Rd} = 7.0$ kN

<sup>1)</sup> Crane rail according to DIN 536 on request: M 16 Ø 18, M 24 Ø 26.

<sup>2)</sup> Also available for crane rails A100 (KS75).

<sup>3)</sup> Also available for crane rails A120 (KS101).

<sup>4)</sup> Dimensions in brackets on left of sketch.

<sup>5)</sup> Other carrier types also available.

<sup>6)</sup> 35 mm at bolt length of 80 mm.

### Ordering Example for Sliding Nut

Type	Thread	Material
JGM B	M 12	ZP

### Ordering Example for Clamping Plate

Type	Ø	Material
KPA 55	-22	HDG

## Ring Nuts according to DIN 582

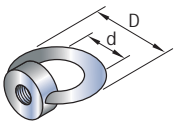
	Thread	d [mm]	D [mm]	$F_{Rd}$ [kN] <sup>1)</sup>	Material
	M 8	20.0	36.0	2.0	Black, ZP
	M 10	25.0	45.0	3.2	
	M 12	30.0	54.0	4.8	
	M 16	35.0	63.0	9.8	
	M 20	40.0	72.0	16.8	
	M 24	50.0	90.0	25.2	

<sup>1)</sup> Load under central tension.

## JORDAHL® Toothed Straps JVB

JORDAHL® toothed straps JVB types Z, ZS, N, and V are used with JORDAHL® anchor channels JTA to transfer high tensile and compressive loads between precast concrete elements. The slot in the strap provides installation adjustment in the direction of load which is restrained by the interlocking

teeth of the toothed strap and matching toothed washer. JORDAHL® anchor channels provide additional adjustment in other planes. This combination of products enables three-dimensional adjustment to accurately align precast elements and compensate for construction tolerances.

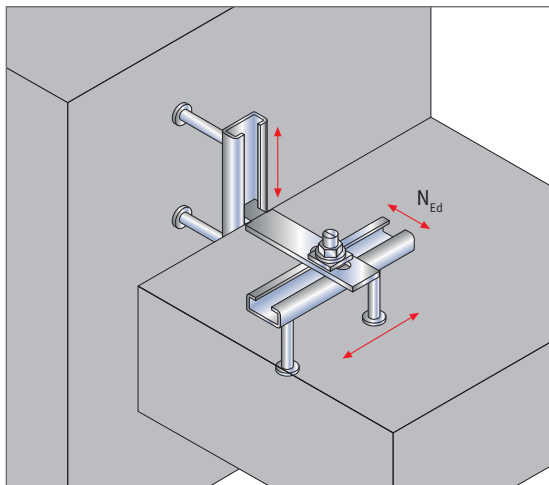

JORDAHL® toothed straps JVB-Z for three-dimensional alignment.

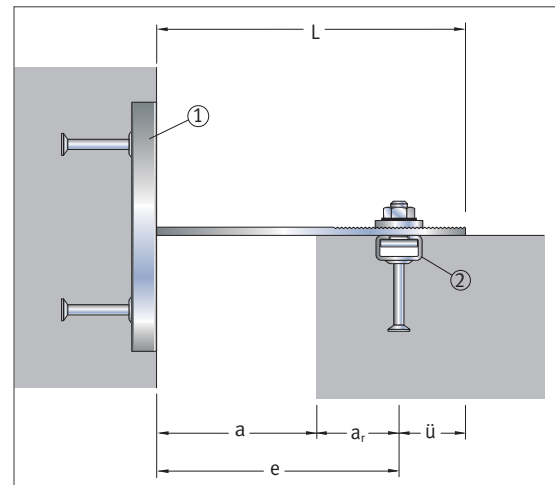

Installation overview.

JORDAHL® toothed straps are available in four types:

- JVB-Z for transferring tension loads while providing connection adjustment (tolerance compensation) of  $\pm 20$  mm
- JVB-N for transferring tension loads while providing connection adjustment of up to  $\pm 38$  mm
- JVB-ZS with welded JORDAHL® T-bolt for transferring both tension and compressive loads, while providing connection adjustment of up to  $\pm 20$  mm
- JVB-V for connections requiring the transfer of shear loads, such as those for the connection of precast elements.

Exact, three-dimensional alignment of the connection is ensured by incorporating vertically and horizontally orientated JORDAHL® anchor channels.

### Scope of supply

JORDAHL® toothed straps include:

- Type JVB-Z (toothed) with counter plate
- Type JVB-Z (toothed) with counter plate, T-bolt, washer, and nut, welded and pre-assembled
- Type JVB-N (toothed slotted hole) with X-washer
- Type JVB-V (toothed holes) with two eccentric inserts

### Material

- Zinc electroplated steel (ZP)
- Stainless steel (A4, L4)



## JVB-Z (for tensile load) and JVB-ZS (for tensile and compressive load)

$N_{Rd}$ [kN]	Type JVB-Z	Type JVB-ZS	Applications		Dimensions [mm]			Fastening Anchor Channel (1)+(2) T-bolt <sup>1)</sup>	Edge Distance $a_e$ [mm]	Material
			Axial Spacing $e \pm 20$ [mm]	Wall Spacing $a$ [mm]	Strap Length $L = a + a_e + \ddot{u}$	Protrusion $\ddot{u}$	Slotted Hole LL			
4.9	JVB-90-Z/12	—	50	0–20	90	40	11 × 55	JTA K 28/15 JD M10 × 30	50	ZP A4
	JVB-115-Z/12	JVB-115-ZS/12	75	5–45	115					
	JVB-140-Z/12	JVB-140-ZS/12	100	30–70	140					
	JVB-165-Z/12	JVB-165-ZS/12	125	55–95	165					
	JVB-190-Z/12	JVB-190-ZS/12	150	80–120	190					
	JVB-215-Z/12	JVB-215-ZS/12	175	105–145	215					
9.8	JVB-240-Z/12	—	200	130–170	240	40	13 × 55	JTA K 38/17 JH M12 × 40	75	
	JVB-115-Z/18	—	75	0–20	115					
	JVB-140-Z/18	JVB-140-ZS/18	100	5–45	140					
	JVB-165-Z/18	JVB-165-ZS/18	125	30–70	165					
	JVB-190-Z/18	JVB-190-ZS/18	150	55–95	190					
	JVB-215-Z/18	JVB-215-ZS/18	175	80–120	215					
	JVB-240-Z/18	—	200	105–145	240					

Please refer to drawings on page 64.

## Toothed Straps JVB-V (for shear load)<sup>2)</sup>

	Type	Load Class	$V_{Rd}$ [kN]	Length $l$ [mm]	Tolerance <sup>2)</sup> [mm]	For T-Bolts <sup>3)</sup>	Material
	JVB-V-2815	3.7	5.0	222	± 9	M12	ZP L4
	JVB-V-3817	7.4	10.0	262	± 14	M12	
	JVB-V-5030	12.8	17.2	294	± 17	M16	

## Toothed Straps JVB-N (for tensile load)<sup>2)</sup>

	Type	Load Class	$N_{Rd}$ [kN]	Distance $e$ [mm]	Tolerance <sup>4)</sup> [mm]	For T-Bolts <sup>1)5)</sup>	Material
	JVB-N-2815-e	3.7	5.0	55 60 80	± 38	M12	ZP L4
	JVB-N-3817-e	7.4	10.0	55 65 80	± 38	M12	
	JVB-N-5030-e	12.8	17.2	60 70 80	± 33	M16	

<sup>1)</sup> Please order the anchor-channel T-bolts (2) (see drawing on page 64) needed to install the toothed straps separately.

<sup>2)</sup> At right angle to anchor channel.

<sup>3)</sup> Through-hole of eccentric insert.

<sup>4)</sup> At right angle to anchor channel, which is also used for lateral adjustment.

<sup>5)</sup> Through-hole of X-washer.

### Ordering Example for Toothed Strap JVB-Z for Wall Spacing $a = 40$ mm

Type	Length $l$	Series	Material
JVB	115	Z/12	A4



### JORDAHL Information

For further information required for the design of precast panel restraint connections, please check the Compact Information "JORDAHL® Toothed Straps JVB-V and JVB-N" or the Design Aid "JORDAHL® Toothed Straps JVB". You can download the documents at [www.jordahl.de](http://www.jordahl.de) → Downloads → Brochures or you can request them by emailing [info@jordahl.de](mailto:info@jordahl.de).

NEW!

NEW!

## JORDAHL® Turnbuckle Connections JSV

Permissible  

$$F = \frac{F_{Rd}}{1.4}$$

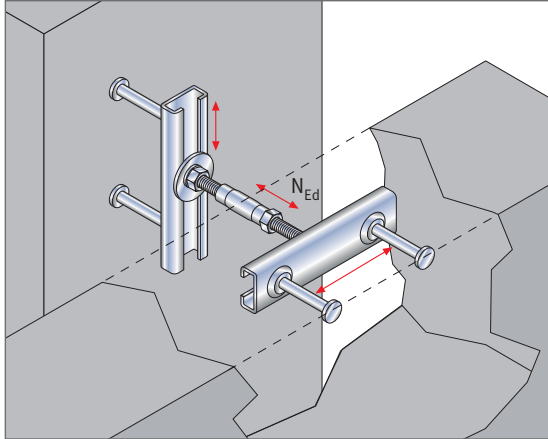

Turnbuckle Connections JSV provide three-dimensional alignment.

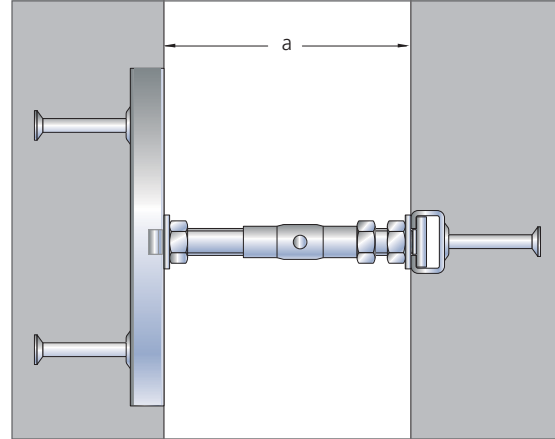

Installation overview.

JORDAHL® JSV turnbuckle connection products are used in combination with vertical and horizontal JORDAHL® anchor channels (minimum length 150 mm). The combination provides accurate three-dimensional adjustment for high load tension and compression connections between concrete components.



### Scope of supply

JORDAHL® JSV connections consist of:

- Turnbuckle (1 piece)
- JORDAHL® T-bolt L including nut with left-hand thread (1 piece)
- JORDAHL® T-bolt R including nut with right-hand thread (1 piece)
- One nut to lock the turnbuckle
- Washers EN ISO 7093-1 (2 pieces)

### Material

- Stainless steel (A4)

Type	$N_{Ed}$ [kN]	Wall Spacing <sup>1)</sup> a [mm]	Turnbuckle Thread Diameter x Length	T-Bolt L Left-Hand Thread	T-Bolt R Right-Hand Thread	Matching Anchor Channel
						l = 150 – 250 mm
JSV-28-1	6 4.9	85–110	SP 10 × 50	JDL-M 10 × 50	JD-M 10 × 40	JTA K 28/15
JSV-28-2		110–160	SP 10 × 80	JDL-M 10 × 50	JD-M 10 × 60	
JSV-38-1	6 7.0	95–115	SP 12 × 50	JHL-M 12 × 50	JH-M 12 × 50	JTA K 38/17
JSV-38-2		115–155	SP 12 × 80	JHL-M 12 × 50	JH-M 12 × 60	
JSV-38-3		145–195	SP 12 × 80	JHL-M 12 × 50	JH-M 12 × 100	
JSV-38-4	6 9.8	95–115	SP 16 × 50	JHL-M 16 × 50	JH-M 16 × 50	JTA K 38/17
JSV-38-5		125–175	SP 16 × 80	JHL-M 16 × 50	JH-M 16 × 80	
JSV-38-6		145–195	SP 16 × 80	JHL-M 16 × 50	JH-M 16 × 100	
JSV-40-1	6 11.1	95–115	SP 16 × 50	JCL-M 16 × 50	JC-M 16 × 60	JTA K 40/25 JTA W 40/22 JTA W40+
JSV-40-2		125–145	SP 16 × 80	JCL-M 16 × 50	JC-M 16 × 60	
JSV-40-3		140–185	SP 16 × 80	JCL-M 16 × 50	JC-M 16 × 100	
JSV-50-1	6 14.0	125-165	SP 16 × 80	JBL-M 16 × 80	JB-M 16 × 50	JTA K 50/30 JTA W 50/30 JTA W 50+ JTA K 53/34 JTA W 53/34 JTA W 55/42
JSV-50-2		150-195	SP 16 × 80	JBL-M 16 × 80	JB-M 16 × 80	
JSV-50-3		170-215	SP 16 × 80	JBL-M 16 × 80	JB-M 16 × 100	

<sup>1)</sup> Additional wall spacing dimensions can be achieved by the use of right-hand thread T-bolts in other lengths.

### Ordering Example for Turnbuckle Connection JSV

$N_{Rd}$  7.0 kN, Existing Wall Spacing 120 mm

Type	Profile Size	Series	Material
JSV	– 38	– 2	– A4

## JORDAHL® Pressure Bolts JDS

JORDAHL® pressure bolts are primarily used in the installation of precast panels and are used to transmit compressive forces resulting from dead weight or wind loads. Tensile forces cannot be restrained.

### Components

The design consists of:

- A plastic sleeve with a nail plate, which is arranged in the precast element or in the in situ concrete
- A suitable bolt with nut and washer made of stainless steel (A4)

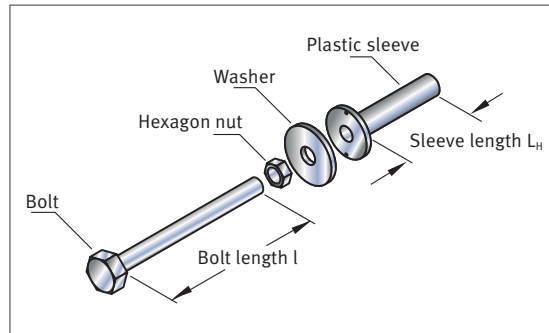

JORDAHL® Pressure bolt.

Permissible  
 $F = \frac{F_{Rd}}{1.4}$

Bolt Length [mm]	For Wall Spacing $a \pm 20$ [mm]	Compressive Force $F_{Rd}$ <sup>1)</sup> [kN]			
		M 10	M 12	M 16	M 20
80	40	10.2	15.4	30.0	47.0
100	60	9.1	14.0	28.0	45.6
120	80	8.1	12.7	26.2	43.1
140	100	7.3	11.6	24.5	40.9
160	120	6.4	10.6	23.0	38.8
180	140	5.7	9.7	21.4	36.7
200	160	5.2	8.8	20.0	34.7
220 <sup>2)</sup>	180	4.6	8.0	18.6	32.9
240 <sup>2)</sup>	200	4.2	7.3	17.4	31.2

<sup>1)</sup> Calculation of the design load capacity (steel failure) according to DIN 18 800 and Z-30.3-6 "Components and joining means of stainless steels".

<sup>2)</sup> Length available on request.

### Notes on installation

In order to allow for adjustment, the bolt should be placed about 15 cm away from the edge of the precast panel. In this case, the edge spacing from the upper edge of the panel should be  $a_r \geq 1.5 \times d$  ( $d$  = panel thickness). You should verify that the forces are transferred to the concrete by installing adequate reinforcement in the area in which the force is introduced.

In combination with an eyelet socket (see page 68), the pressure bolt joint can also be braced against unintentional detachment.

### Ordering Example for Pressure Bolt JDS

Type	Thread Ø	Bolt Length [mm]	Material
JDS	M 10	x 80	A4

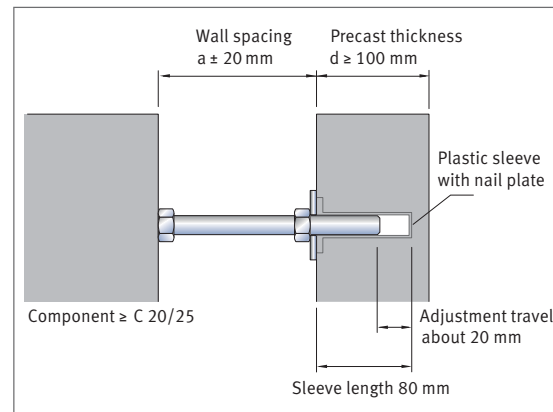

Installation.

## Coupling Sleeves

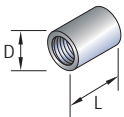
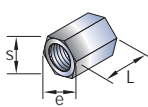
Round	Thread	D [mm]		L [mm]	F <sub>Rd</sub> [kN]	Material	
	M 6	10.0		20.0	3.1	ZP A4 on request	
	M 8	11.0		20.0	5.6		
	M 10	13.0		25.0	9.0		
	M 12	15.0		30.0	13.0		
	M 16	22.0		40.0	24.0		
	M 20	28.0		50.0	37.8		
Hexagon <sup>1)</sup>	Thread	e [mm]	s [mm]	L [mm]	F <sub>Rd</sub> [kN]		Material
	M 6	11.05	10.0	15.0	A4-50	4.6	ZP A4 on request
	M 8	14.38	13.0	20.0	6.4	7.4	
	M 10	18.90	17.0	25.0	10.1	11.6	
	M 12	21.10	19.0	30.0	14.8	16.9	
	M 16	26.75	24.0	40.0	27.4	31.4	
	M 20	32.95	30.0	50.0	42.8	49.0	

<sup>1)</sup> with inspection hole, on request.

## Eyelet Sockets/Sleeve Anchors

JORDAHL® eyelet sockets are used to transfer tensile forces into concrete components, as occur, for example, when transporting precast elements. The eyelet sockets are cast into the reinforced concrete components. A reinforcing bar of the largest possible diameter is fed

through the eyelet transverse hole and bent down into the concrete component. The reinforcing bar is required to transfer the connection load from the eyelet socket into the concrete and needs to be carefully dimensioned by the engineer to ensure sufficient bond is achieved.

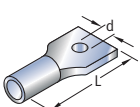
	Thread	L [mm]	d [mm]	F <sub>Rd</sub> [kN]	min a <sub>r1</sub> [mm]	Material
	M 8	50	6.2	3.5	75	A4 ZP
	M 10	50	6.2	4.9	75	
	M 12	60	7.2	7.0	90	
	M 16	80	12.2	11.2	120	

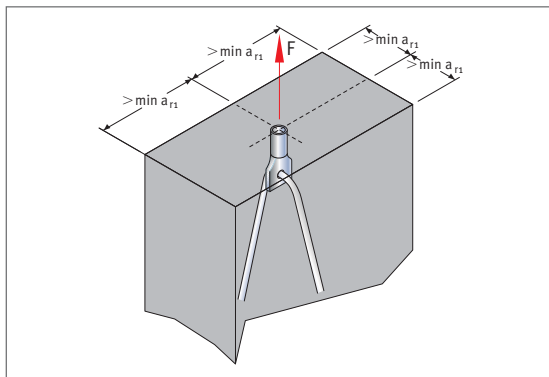

### Ordering Example for Eyelet Socket

Type	Thread Ø	Length [mm]	Material
ÖM	M 10	x 50	A4

# JORDAHL® Channels for Self-Drilling Screws JTB



German Technical Approval  
Z-21.4-161

JORDAHL® channels for self-drilling screws JTB are the perfect solution for fastening profiled metal sheets and other lighter duty components to reinforced concrete structures without damaging the concrete or reinforcement. Channel types JTB-AR and JTB-uni are available.

## Significant Benefits

- Slim channel body fits easily in concrete cover above reinforcement
- Rapid installation with two-dimensional adjustment for connections
- Easy adjustable self-drilling connections without damage to concrete or reinforcement
- Suitable for many typical light duty connections to concrete
- Guaranteed load-bearing capacity with building approval
- Approved post-applied end anchor so that channel can be safely cut to required length



## Channels for Self-Drilling Screws JTB-AR

- With centrally arranged loop anchors
- For easier fit into existing reinforcement cages



## Channels for Self-Drilling Screws JTB-uni

- With external slim-headed anchors
- For quick assembly, even in heavily reinforced components
- Minimum space required for storage, as they can be stacked on top of each other



# JORDAHL® Channels for Self-Drilling Screws JTB

JORDAHL® channels for self-drilling screws JTB deliver fast, cost-effective light duty fastening to reinforced concrete components. Due to their low profile, JTB-AR and JTB-uni channels can be installed very easily into concrete elements with reduced cover to reinforcement.

JORDAHL® channels for self-drilling screws JTB and the associated end anchors have building approval:  
**JTB: Z-21.4-161.**

## Material

- Steel according to DIN EN 10 025, hot-dip galvanized with  $\geq 50 \mu\text{m}$  zinc coating
- Stainless steel 1.4571 or 1.4401/ 1.4404 (A4)

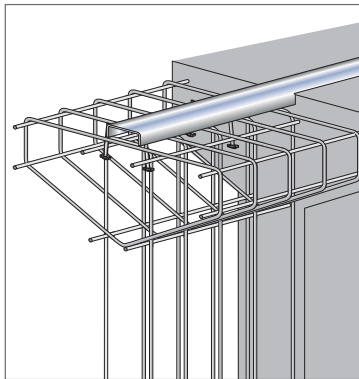

Installation in heavily reinforced elements

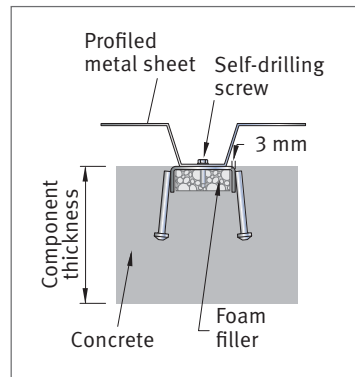

JTB-uni

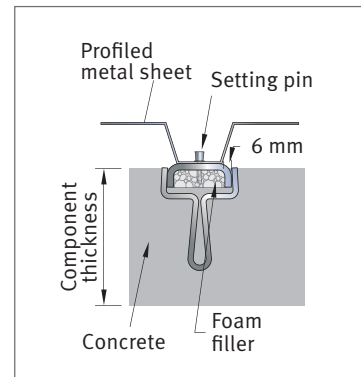

JTB-AR.



Installed on wall.



Installed on roof.



Storage of JTB-AR.



JTB-uni has minimum space requirements for storage.

## Technical Details

### Forms supplied

Channels for self-drilling screws JTB-AR and JTB-uni are supplied with anchors at either 150 mm or 450 mm spacing (stock length is 3000 mm in each case).

- Can be cut at the centre, therefore often particularly cost-effective, anchor spacing  $e = 450$  mm

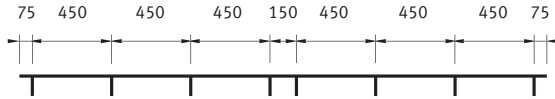

- Can be cut at any point, anchor spacing  $e = 150$  mm

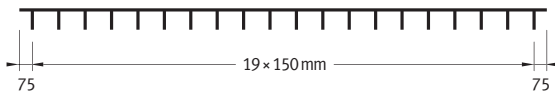

For special cases where these variants cannot be used, approved end anchors are available, which are fixed to the channels by self-drilling screws.

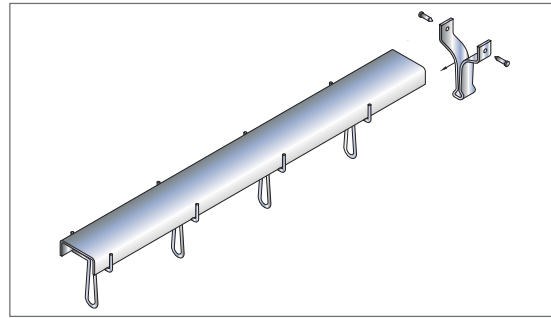

JTB-AR with end anchor.

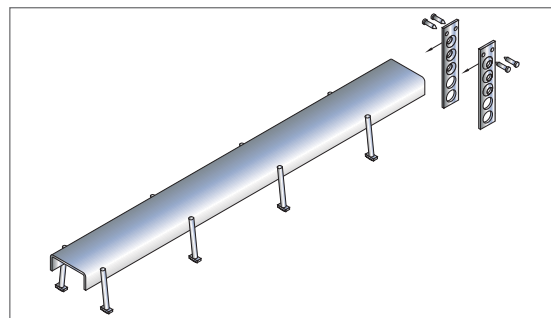

JTB-uni with end anchor.

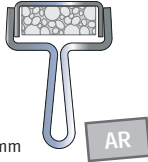
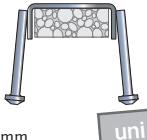
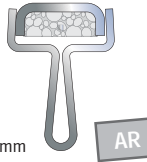
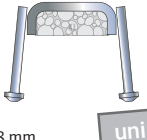
Technical Details				
Profile (w/h/d) [mm]	JTB 60/24/3-AR	JTB 60/24/3-uni	JTB 60/22/6-AR	JTB 60/22/6-uni
Installation height	 100 mm	 68 mm	 100 mm	 68 mm
Anchor spacing $e$ [mm]	150 or 450			
Cross section $A$ [cm <sup>2</sup> ]	2.97		5.06	
Moment of inertia $I_y$ [cm <sup>4</sup> ]	1.51		1.88	
Moment of resistance $W_y$ [cm <sup>3</sup> ]	0.87		1.286	
Weight with anchors [kg/m]	2.5	2.4	4.1	4.0
Material and corrosion protection	S235JR (St 37-2), hot-dip galvanised $\geq 50 \mu\text{m}$ or 1.4571/1.4401 (A4)			
Typical self-drilling screws for connection <sup>1)</sup>	HDG	e.g., EJOT self-tapping screw: JT 2-6-6, 3 × 22, V16		e.g., EJOT setting bolt: SBR 14
	Stainless steel	e.g., EJOT Cronimax: JZ 7-6.3 × 22, E16 drill $\varnothing$ 5.5 mm		

<sup>1)</sup> Manufacturer's approvals must be followed.

## Technical Details

### Design resistance $F_{Rd}$

Permissible  
 $F = \frac{F_{Rd}}{1.4}$

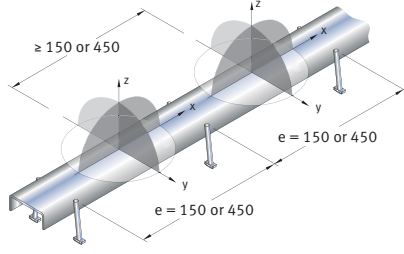
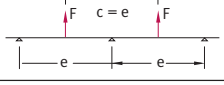
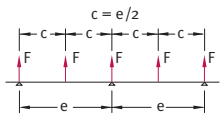
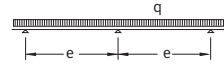
Profile	JTB 60/24/3		JTB 60/22/6		Loading Areas $\sqrt{N_{Ed}^2 + V_{Ed}^2 + X_{Ed}^2} \leq F_{Rd}$ 
Anchor distance $e$ [mm]	150	450	150	450	
Unit load $F_{Rd}$ [kN] 	7.0	4.6	7.0	7.0	
 $c = e/2$	3.5	3.5	3.5	3.5	
Distributed load $q$ [kN/m] 	46.6	15.5	46.6	15.5	

## Installation and Assembly

Polystyrene-filled JTB channels are installed into the concrete with the upper steel face flush with the concrete surface. In continuous runs, the end joints between adjoining channels should be about 20 mm. After stripping the formwork, profiled metal cladding sheets or other components can be attached to the channel by

approved self-drilling screws or set screws. Connections to the channels must be made within the central third of the channel width. The axis of the last connections must be at least 2.5 cm from the end of the channel. The applicable installation standards for connected components must be observed.

### End anchors

Hot-dip galvanised channels that are shortened on site to custom lengths must have approved end anchors installed at 75 mm from each cut end of the channel.

Self-drilling screws ST 4.8 × 16 ZP according to DIN EN ISO 15481 can be used to fasten the end anchors.

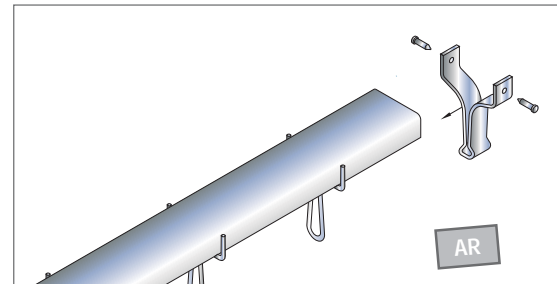

JTB-AR channel with JTB-EA end anchors.

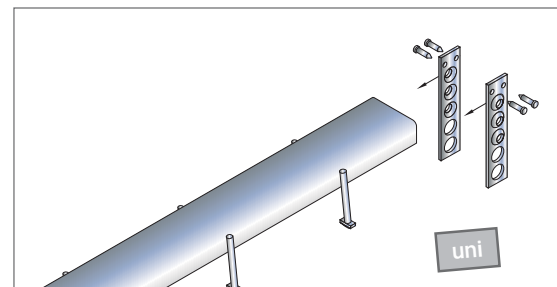

JTB-uni channel with JTB-EB end anchors.

### Design resistance $F_{Rd}$

End Anchors		
Fastening Channel	End Anchors	$F_{Rd}$ [kN]
JTB-AR	JTB-EA	4.9
JTB-uni	JTB-EB	4.9



### Minimum dimensions [mm]

	$a_a$ <sup>1)</sup>	$a_r$ <sup>2)</sup>	$a_e$ <sup>3)</sup>	$a_f$ <sup>4)</sup>	$d$ <sup>5)</sup>	$b$ <sup>6)</sup>
Type JTB-AR	200	100	20	20	100 + c	200
End Anchor JTB-EA	160	80	20	20	105 + c	200
Type JTB-uni	200	120	20	20	68 + c	240
End Anchor JTB-EB	200	100	20	20	125 + c	200

<sup>1)</sup> If adjacent channels are arranged in a staggered manner so that the anchors are spaced apart by at least 150 mm from each other, the lateral spacing  $a_a$  may be reduced to 80 mm.

<sup>2)</sup> If the permissible anchor load is not fully utilised, the edge spacing  $a_r$  may be **reduced** to the following, for central tension loading only:

$$\text{red. } a_r = N_{Ed}/N_{Rd} \times a_r \geq 5 \text{ cm}$$

$N_{Ed}$  = design force

$N_{Rd}$  = design resistance

<sup>3)</sup> If the anchor force is fully utilised, the last anchor must be at least 90 mm away from the edge.

<sup>4)</sup> If the anchor force is fully utilised, the two end anchors must be spaced at least 150 mm from each other.

<sup>5)</sup> This is calculated from the dimensions of the anchors and the required concrete covering  $c$  according to DIN EN 1992-1-1 with DIN EN 1992-1-1/ NA:2011-01, para. 4.4.

<sup>6)</sup> Minimum component width when only one channel is installed.

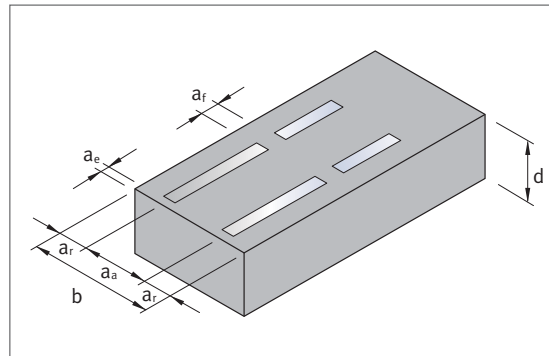

### Ordering Example for Channels for Self-Drilling Screws JTB

Type	Size	Anchor Distance [mm]	Anchor	Material
JTB	60/24/3	- 450 -	uni	A4



Installation of a multi-layer insulated profiled metal sheet wall.

# JORDAHL® Products for Brick Restraint

## Brick Tie Anchors JMA and Nail Anchors JNA

Brick tie channels and the associated brick tie anchors ensure the permanent and secure connection of masonry or timber components to an adjacent concrete structure. The brick tie anchors are twisted into the brick tie channels and pressed into the mortar joints at spacings that comply with design and code requirements.

There are two ranges with many variants: JMA: straight format, T format (Q), L format (QE); JMA-D in an extra flat format to connect large-format porous concrete masonry; and nail anchors JNA.

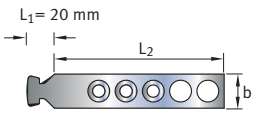
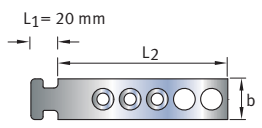
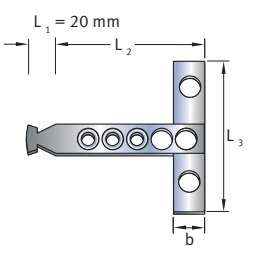
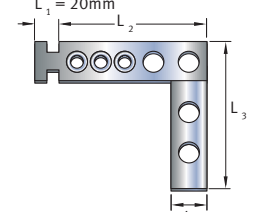
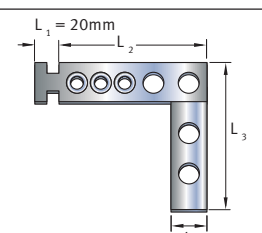
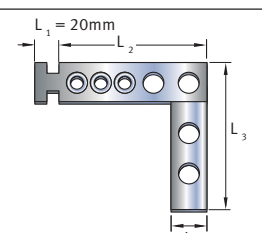
Brick Tie Anchors JMA for Thick Mortar Joints Material: HDG, A4		Cavity a [mm]	Dimensions			
			b [mm]	t [mm]	L <sub>2</sub> [mm] <sup>1)</sup>	L <sub>3</sub> [mm]
	JMA-L <sub>2</sub> /12 (Series 12) <sup>1)</sup>	20–40 40–80 85–140	25	2	85 120 180	—
		140–160		3	300	
	JMA-L <sub>2</sub> /18 (Series 18)	20–40 40–80 85–140 140–160	30	3	85 120 180 300	—
	JMA-L <sub>2</sub> × L <sub>3</sub> -Q/12, (series 12)	20–40 40–80 85–140	25	2	85 120 180	120 180 300
		140–160		3	300	
	JMA-L <sub>2</sub> × L <sub>3</sub> -Q/18 (series 18)	20–40 40–80 85–140 140–160	30	3	85 120 180 300	
		JMA-L <sub>2</sub> × L <sub>3</sub> -QE/12 (series 12)	20–40 40–80 85–140	25	2	85 120 180
		140–160	3		300	
	JMA-L <sub>2</sub> × L <sub>3</sub> -QE/18 (series 18)	20–40 40–80 85–140 140–160	30	3	85 120 180 300	

<sup>1)</sup>The necessary length L<sub>2</sub> must be determined taking into account the cavity dimension, the thickness of the facing brickwork, and the required minimum embedment of the anchor according to regulation.

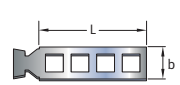
Brick Tie Anchors JMA for Thin Mortar Joints Material: A2	Dimensions		Length
	b [mm]	s [mm]	L [mm]
	25	1	125
			185
			245

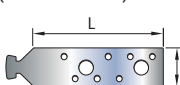
Nail Anchors JNA Material: HDG	Dimensions		Length
	b [mm]	s [mm]	L [mm]
	35	3	100
			130
			200

### Ordering Example for Brick Tie Anchors JMA-QE

Type	Length L <sub>2</sub> × L <sub>3</sub>	Variant	Series	Material
JMA	85 × 120	—	QE / 12	A4

### Ordering Example for Brick Tie Anchors JMA

Type	Length	Series	Material
JMA	120 /	12	A4

## Brick Tie Channels

### Connection

JORDAHL® brick tie anchor JMA has several connection options to ensure the permanent and safe connection of brickwork to adjacent components.

- Cast-in JORDAHL® anchor channels JTA
- JORDAHL® mounting channels JM that can also be surface-mounted to wood and steel components
- Cast-in JORDAHL® brick tie channels Kt 25/15-D with integrated, bend-out profiled anchors (available channel lengths of 2.5 m and 5.0 m)

### Material

The brick tie channels and anchors are made in stainless steel 1.4571 or 1.4401 (A4) for exterior applications, and in hot-dip galvanised steel for internal applications.

### Design

Brick tie channels are available in different cross sections to provide a range of load capacities suitable for the permanent and safe connection of brickwork to adjacent components.



Connection of brickwork support shells to reinforced concrete components with brick tie channel Kt 28/15-D and anchor.

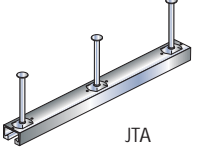
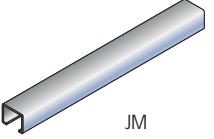
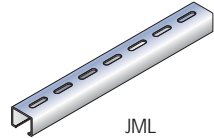
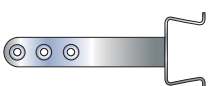

Connection of brickwork to sheet-pile wall.

Brick Tie Channels		Material	Corresponding Brick Tie Anchors and Nail Anchors
 <p>JTA</p>	<p>JTA K 28/15 JM K 28/15 JML K 28/15</p>	<p>HDG A2 A4</p>	<p>JMA-L<sub>2</sub>/12 JMA-L<sub>2</sub> × L<sub>3</sub>-Q/12 JMA-L<sub>2</sub> × L<sub>3</sub>-QE/12 JMA-L-D/12 JNA-L/12 (Series 12)</p>
 <p>JM</p>	<p>JTA K 38/17 JM K 38/17 JML K 38/17</p>	<p>HDG A2 A4</p>	<p>JMA-L<sub>2</sub>/18 JMA-L<sub>2</sub> × L<sub>3</sub>-Q/18 JMA-L<sub>2</sub> × L<sub>3</sub>-QE/18 JNA-L/18 (Series 18)</p>
 <p>JML</p>			
	<p>Kt 25/15-D with profiled anchor</p>	<p>pg<sup>1)</sup> A4</p>	<p>JMA-L<sub>2</sub>/12 JMA-L<sub>2</sub> × L<sub>3</sub>-Q/12 JMA-L<sub>2</sub> × L<sub>3</sub>-QE/12 JMA-L-D/12 JNA-L/12 (Series 12)</p>

<sup>1)</sup> pg = pre-galvanised.

# JORDAHL® Scaffold Shoes JG

JORDAHL® scaffold shoes JG are used to safely install mounting platforms in elevator shafts. Scaffold shoes are available in different models for various load categories. The standard design is for square timber

widths of 10 cm. Scaffold shoes for square timber widths of 12 cm are available on request. They are made of hot-dip galvanised steel and delivered with colour corrosion protection paint as per the load category.

## Type H

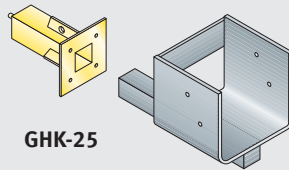

GHK-25

### Type H 2.5

$V_{Rd} = 4.2 \text{ kN}^{(1)}$

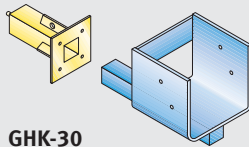

GHK-30

### Type H 5/9

$V_{Rd} = 7.7 \text{ kN}^{(1)}$

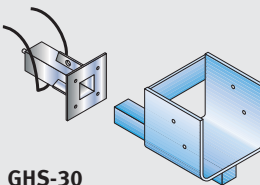

GHS-30

### Type H 5/9

$V_{Rd} = 13.9 \text{ kN}^{(1)}$

## Type K

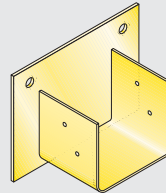

### Type K 4

$V_{Rd} = 6.2 \text{ kN}^{(1)}$

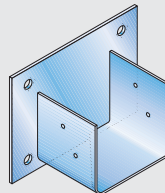

### Type K 9

$V_{Rd} = 13.9 \text{ kN}^{(1)}$

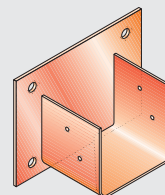

### Type K 12

$V_{Rd} = 18.5 \text{ kN}^{(1)}$

## Type L

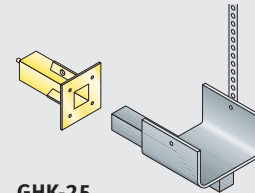

GHK-25

### Type L 2.5

$V_{Rd} = 4.2 \text{ kN}^{(1)}$

### Ordering Example for Scaffold Shoes JG

Type
JG-K 4

### Ordering Example for Frame Sleeves

Type	Size
GHK	– 25



Certificate No. R 60085529

<sup>1)</sup> Design resistance including load increase factor 1.1.



### JORDAHL Information

Do you want to find out more about JORDAHL elevator installation products? Take a look at our "JORDAHL Products for Lift Construction" catalogue at [www.jordahl.de](http://www.jordahl.de) → Downloads → Brochures or simply scan the QR code.



# JORDAHL® Edge Protection Angles JKW

Cast-in JORDAHL® edge protection angles JKW are used to strengthen the corners of columns and walls, e.g., in car parks and warehouse loading bays. They are supplied with anchors ready to install. The round steel anchors bent in a U-shape can be fitted easily into the reinforcing cage and do not obstruct the corner reinforcement. The edge protection angles are bent at an angle of 92°. This ensures good contact with the formwork and a clean edge to the concrete.

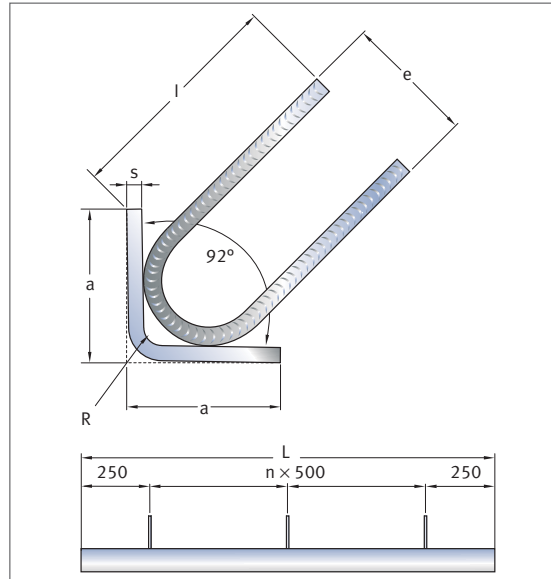

## Material

Stainless steel:

- Angle – 1.4301 (A2)  
– 1.4401/1.4404/1.4571 (A4)  
– 1.4362 (L4 Duplex)
- Anchor – B500B NR or B500B

Hot-dip galvanised steel:

- Angle – 1.0038 (steel)
- Anchor – B500B



Type	Angle Dimensions a × a × s [mm]	Lengths L [mm]	Number of Anchors	Approx. Anchor Dimension l × e [mm]	Angle Radius R [mm]
JKW-50/5-L	50 × 50 × 5	500, 750, 1000	2	80 × 50	5
		1500	3		
		2000	4		
JKW-80/6-L	80 × 80 × 6	500, 750, 1000	2	125 × 50	13
		1500	3		
		2000	4		
JKW-100/6-L	100 × 100 × 6	500, 750, 1000	2	115 × 50	13
		1500	3		
		2000	4		
JKW-100/8-L	100 × 100 × 8	500, 750, 1000	2	115 × 50	13
		1500	3		
		2000	4		

## Ordering Example for Edge Protection Angle JKW

Type	Profile Size	Length [mm]	Material
JKW	– 80/6	– 750	– A2

# JORDAHL® Channel Brackets JKO

Permissible

$$F = \frac{F_{Rd}}{1.4}$$

JORDAHL® channel brackets JKO 28/28-1, 36/36-1, and 36/36-2 are typically used to support building services such as pipes and cable trays. They are attached to the structure using either cast-in anchor channels or drilled bolts. Special designs can also be supplied on request.



	<b>JKO 28/28-1</b>	<b>JKO 36/36-1</b>	<b>JKO 36/36-2</b>				
<b>Cantilever Profile</b>	K 28/28	K 36/36	K 36/36				
<b>Corresponding T-Bolt</b>	Type JD, M 6-12	Type JH, M 10-16	Type JH, M 10-16				
<b>Vertical Profile for T-Bolts</b>	U 36/24 M 12	U 45/27 M 12	U 45/27 M 12				
<b>Bracket Projection L [mm]</b>	100, 200, 300, 400	300, 400, 500, 600	300	400	500	600	700
<b>Height h [mm]</b>	120	180	208	238	269	300	330
<b>Design/Material</b>	Hot-dip galvanised steel $\geq 50 \mu\text{m}$ , stainless steel upon request						

		$N_{Rd}$ [kN] <sup>1)</sup>													
		Load case 1:							Load case 2:						
		Bracket Projection L [mm]							Bracket Projection L [mm]						
		100	200	300	400	500	600	700	100	200	300	400	500	600	700
JKO 28/28-1		3.78	1.89	1.26	0.98	—	—	—	1.89	0.95	0.63	0.49	—	—	—
JKO 36/36-1		—	—	2.80	2.10	1.68	1.40	—	—	—	1.40	1.05	0.84	0.70	—
JKO 36/36-2		—	—	7.00	5.81	4.41	3.57	2.94	—	—	5.88	5.74	5.11	4.69	4.41

<sup>1)</sup> All load-bearing capacities have been calculated elastically and plastically in accordance with DIN 18 800 (1/90) with the following assumptions:  $\gamma_f = 1.4$ ;  $\gamma_{MS} = 1.1$ ; yield point  $f_{y,k} = 235 \text{ N/mm}^2$ ; deflection  $f \leq l / 150$  for steel.

## Ordering Example for Channel Brackets JKO

Type	Profile Size	Projection [mm]	Material
JKO	28/28-1	— 200	HDG

# Advice and Service



JORDAHL experts: Application consultant Rolf Ratsch and product developer Elisabeth Smith.

## The JORDAHL Experts

Would you like advice on our products? Our JORDAHL experts are available from Monday to Thursday between 8 a.m. and 5.30 p.m. and Friday between 8 a.m. and 4 p.m.

By email: [experten@jordahl.de](mailto:experten@jordahl.de)  
By phone: +49 30 682 83-433

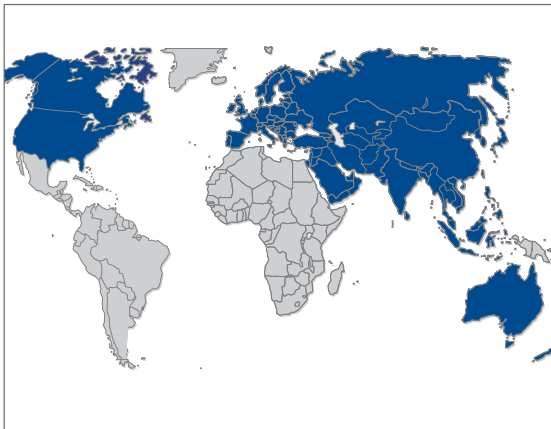

## Where to buy

Our products are used in construction projects around the world because of their acknowledged high quality. You can purchase JORDAHL products from JORDAHL subsidiary companies and distributors located around the world.

For specific questions regarding JORDAHL products, inquiries, and orders, you will find all the contact information at [www.jordahl.de](http://www.jordahl.de) → [Contact](#) → [JORDAHL International](#)

## Installation videos

To achieve optimal results when using JORDAHL® anchor channels, installation videos are available, e.g., for anchor channels and profiled metal sheet fastenings. You can find these installation videos and other installation instructions and videos at [www.jordahl.de](http://www.jordahl.de) → [Service](#).

## CAD drawings and BIM files

To integrate JORDAHL® anchor channels and mounting channels into your planning and design processes, we provide BIM files in addition to conventional CAD files. The files can be downloaded free of charge from the download section of our website located at [www.jordahl.de](http://www.jordahl.de) → [Downloads](#).

## Specification texts

For all JORDAHL products, ready-made specification texts comprising all relevant technical specifications with regard to material, load-bearing capacity, sizes, and installation notes are available at [www.jordahl.de](http://www.jordahl.de) → [Service](#). The data can be exported (e.g., in the GAEB format), sent out as an email attachment, or saved to file.

## Catalogues

Are you interested in other JORDAHL products or do you require additional information on a specific product? A large number of brochures are available for download at [www.jordahl.de](http://www.jordahl.de) → [Downloads](#).

# Index

## A

Anchor Channels	12
■ Anchor Channel Pairs	31
■ Corner Pieces	31
■ Curved Anchor Channels	31
■ Dynamic Load	26
■ Fire Exposure	25
■ Identification	10
■ JGB, Handrail Connection Channels	33
■ JRA W 74/48, Hot-Rolled Profile	38
■ JSA, Cold-Formed Profile	37
■ JTA-CE, Hot-Rolled and Cold-Formed Profiles	12
■ JTA-RF; JTA-RT, Facade Connection Channels	35
■ JXA, Hot-Rolled Toothed Profiles	20
■ JXA-PC, Hot-Rolled Toothed Profiles	21
■ JZA, Cold-Formed Toothed Profiles	20
■ Product Range JTA, JXA, and JZA	24
■ Site Use	28
Applications and Uses	4
Approvals and Certificates	8

## B

Brick Tie Anchors JMA	74
Brick Tie Channels	75

## C

Channel Brackets JKO	78
Channel Nuts JAM	62
Channels for Self-Drilling Screws JTB	69
■ Installation and Assembly	72
■ Technical Details	71
Clamping Claw SKU	63
Corrosion Prevention	11
Coupling Sleeves Round/Hexagon	68

## D

Double-Toothed Shims JKZS	61
Double-Notch Toothed T-Bolts JKB, JKC	54

## E

Edge Protection Angles JKW	77
EXPERT Software	16
Eyelet Sockets	68

## F

Facade Connection Channels JTA-RF, JTA-RT	35
Flange Clamping Plates JKP	63

## H

Hammer-Head T-Bolts JD, JG, JH	51
Handrail Connection Channels JGB	33
Hexagon Nuts according to ISO 4032	61
Hook-Head T-Bolts JA, JB, JC, JE	50

## I

Identification	10
----------------	----

## M

Material	10
Mounting Channels	40
■ Attachment to Substrate	43
■ JM K, Cold-Formed Profiles	44
■ JM W, Hot-Rolled Profiles	42
■ JML, Slotted-Back Mounting Channels	45
■ JXM, Hot-Rolled Toothed Profiles	42
■ JZM, Cold-Formed Toothed Profiles	45
■ Technical Details	46

## N

Nail Anchors JNA	74
------------------	----

## P

Pre-Loaded Bolt Connections	56
Pressure Bolts JDS	67

## R

Ring Nuts according to DIN 582	64
--------------------------------	----

## S

Scaffold Shoes JG	76
Self-Locking Nuts with Serrated Flange	61
Sleeve Anchors	68
Sliding Nuts JGM	62
Spring Washers DIN 127	61
Square Shim JVL	60

## T

T-Bolts	48
■ Determining the T-Bolt Length	49
■ JA; JB; JE; JC Hook-Head T-Bolts	50
■ JH; JD; JG Hammer-Head T-Bolts	51
■ JKB; JKC Double-Notch Toothed T-Bolts	54
■ JXE; JXB; JXH; JXD; JZS Toothed T-Bolts	54
■ Position Identification	49
■ Pre-Loaded Bolt Connections	56
■ Technical Details	52
■ Tightening Torque/Installation	29
Threaded Rods DIN 976-1	63
Toothed Anchor Channels JXA, JZA, JXA-PC (see also Anchor Channels)	18
■ Technical Details	22
Toothed Straps	64
■ JVB-N	65
■ JVB-V	65
■ JVB-Z	65
■ JVB-ZS	65
Toothed T-Bolts JXB, JXD, JXE, JXH, JZS	54
Turnbuckle Connections JSV	66
Turnbuckle SP	66

## W

Washers	60
---------	----



**JORDAHL GmbH**  
Nobelstr. 51  
12057 Berlin  
Tel +49 30 68283-02  
Fax +49 30 68283-497  
[www.jordahl.de](http://www.jordahl.de)  
[info@jordahl.de](mailto:info@jordahl.de)